



***43UT782V0UA
43UT782V2UA
43UT782V9UA**

** When no suffix distinction (0UA, 2UA, or 9UA) is required, this document simply refers to the UT782V.*

Guest Interactive Pro:Centric[®] TVs

Commercial Mode Setup Guide

Note: Selected features shown in this guide may not be available on all models.

EXPERIENCED INSTALLER

First Use Wizard
pages 18 – 19

Custom Master TV Setup
pages 54 – 56

Cloning Procedures
pages 57 – 63

For Customer Support/Service, please call:
1-888-865-3026

The latest product information and documentation is available online at:
www.lg.com/us/business

MODEL and SERIAL NUMBER

The model and serial numbers of this TV are located on the back of the cabinet. For future reference, LG suggests that you record those numbers here:

Model No. _____ Serial No. _____



WARNING:

TO REDUCE THE RISK OF ELECTRIC SHOCK DO NOT REMOVE COVER (OR BACK). NO USER-SERVICEABLE PARTS INSIDE. REFER TO QUALIFIED SERVICE PERSONNEL.



The lightning flash with arrowhead symbol, within an equilateral triangle, is intended to alert the user to the presence of uninsulated “dangerous voltage” within the product’s enclosure that may be of sufficient magnitude to constitute a risk of electric shock to persons.



The exclamation point within an equilateral triangle is intended to alert the user to the presence of important operating and maintenance (servicing) instructions in the literature accompanying the appliance.

WARNING:

TO PREVENT FIRE OR SHOCK HAZARDS, DO NOT EXPOSE THIS PRODUCT TO RAIN OR MOISTURE.

WARNING:

This product contains chemicals known to the State of California to cause cancer and birth defects or other reproductive harm. **Wash hands after handling.**

NOTE TO CABLE/TV INSTALLER:

This reminder is provided to call the cable TV system installer’s attention to Article 820-40 of the National Electrical Code (U.S.A.). The code provides guidelines for proper grounding and, in particular, specifies that the cable ground shall be connected to the grounding system of the building, as close to the point of the cable entry as practical.

REGULATORY INFORMATION:

This equipment has been tested and found to comply with the limits for a Class B digital device, pursuant to Part 15 of the FCC Rules. These limits are designed to provide reasonable protection against harmful interference when the equipment is operated in a residential installation. This equipment generates, uses and can radiate radio frequency energy and, if not installed and used in accordance with the instruction manual, may cause harmful interference to radio communications. However, there is no guarantee that interference will not occur in a particular installation. If this equipment does cause harmful interference to radio or television reception, which can be determined by turning the equipment off and on, the user is encouraged to try to correct the interference by one or more of the following measures:

- Reorient or relocate the receiving antenna.
- Increase the separation between the equipment and receiver.
- Connect the equipment to an outlet on a circuit different from that to which the receiver is connected.
- Consult the dealer or an experienced radio/TV technician for help.

CAUTION:

Do not attempt to modify this product in any way without written authorization from LG Electronics U.S.A., Inc. Unauthorized modification could void the user’s authority to operate this product.

COMPLIANCE:

The responsible party for this product’s compliance is: LG Electronics U.S.A., Inc.
1000 Sylvan Avenue, Englewood Cliffs, NJ 07632, USA • Phone: 1-201-816-2000

Marketed and Distributed in the United States by LG Electronics U.S.A., Inc.
1000 Sylvan Avenue, Englewood Cliffs, NJ 07632

IMPORTANT SAFETY INSTRUCTIONS

1. Read these instructions.
2. Keep these instructions.
3. Heed all warnings.
4. Follow all instructions.
5. Do not use this apparatus near water.
6. Clean only with dry cloth.
7. Do not block any ventilation openings. Install in accordance with the manufacturer's instructions.
8. Do not install near any heat sources, such as radiators, heat registers, stoves, or other apparatus (including amplifiers) that produce heat.
9. Do not defeat the safety purpose of the polarized or grounding-type plug. A polarized plug has two blades with one wider than the other. A grounding-type plug has two blades and a third grounding prong. The wide blade or the third prong are provided for your safety. If the provided plug does not fit into your outlet, consult an electrician for replacement of the obsolete outlet.
10. Protect the power cord from being walked on or pinched, particularly at plugs, convenience receptacles, and the point where it exits from the apparatus.
11. Only use attachments/accessories specified by the manufacturer.
12. Use only with the cart, stand, tripod, bracket, or table specified by the manufacturer or sold with the apparatus. When a cart is used, use caution when moving the cart/apparatus combination in order to avoid injury from tip-over.



13. Refer all servicing to qualified service personnel. Servicing is required when the apparatus has been damaged in any way, such as power-supply cord or plug is damaged, liquid has been spilled or objects have fallen into the apparatus, the apparatus has been exposed to rain or moisture, does not operate normally, or has been dropped.
14. Never touch this apparatus or antenna during a thunder or lightning storm.
15. Do not apply pressure on or scratch the TV panel during handling. Do not press against the TV panel with your hand or a sharp object such as a nail, pencil, or pen.

16. Power Cord

Caution: Check the TV specifications in the Owner's Manual to determine power requirements.

Periodically examine the cord of your appliance, and if its appearance indicates damage or deterioration, unplug it, discontinue use of the appliance, and have the cord replaced with an exact replacement part by an authorized servicer. Protect the power cord from physical or mechanical abuse, such as twisting, kinking, or pinching or being closed in a door or walked upon. Pay particular attention to plugs, wall outlets, and the point where the cord exits the appliance.

Do not use a damaged or loose power cord. Be sure to grasp the plug when unplugging the power cord. Do not pull on the power cord to unplug the TV.

Do not stick metal objects or any other conductive material into the power cord. Do not touch the end of the power cord while it is plugged in.

17. Overloading

Do not connect too many appliances to the same AC power outlet as this could result in fire or electric shock. Do not overload wall outlets. Overloaded wall outlets, loose or damaged wall outlets, extension cords, frayed power cords, or damaged or cracked wire insulation are dangerous. Any of these conditions could result in fire or electric shock.

18. Outdoor Use/Wet Location

 **Warning: To reduce the risk of fire or electrical shock, do not expose this product to rain, moisture or other liquids.**

Do not touch the TV with wet hands. Do not install this product near flammable objects such as gasoline or candles or expose the TV to direct air conditioning.

Do not expose to dripping or splashing and do not place objects filled with liquids, such as vases, cups, etc., on or over the apparatus (e.g., on shelves above the unit).

19. Grounding

(Except for devices that are not grounded) Ensure that you connect the earth ground wire to prevent possible electric shock (i.e., a TV with a three-prong grounded AC plug must be connected to a three-prong grounded AC outlet). If grounding methods are not possible, have a qualified electrician install a separate circuit breaker. Do not try to ground the unit by connecting it to telephone wires, lightning rods, or gas pipes.

20. Disconnect Device

The power plug is the disconnecting device. The power plug must remain readily accessible.

As long as this unit is connected to the AC wall outlet, it is not disconnected from the AC power source even if the unit is turned off.

(Continued on next page)

IMPORTANT SAFETY INSTRUCTIONS

(Continued from previous page)

21. Outdoor Antenna Grounding

If an outside antenna or cable system is connected to the product, follow the precautions below.

An outdoor antenna system should not be located in the vicinity of overhead power lines or other electric light or power circuits or where it can come into contact with such power lines or circuits as death or serious injury can occur.

Be sure the antenna system is grounded so as to provide some protection against voltage surges and built-up static charges.

Article 810 of the National Electrical Code (NEC) in the U.S.A. provides information with respect to proper grounding of the mast and supporting structure, grounding of the lead-in wire to an antenna-discharge unit, size of grounding conductors, location of antenna-discharge unit, connection to grounding electrodes, and requirements for the grounding electrode.

Antenna Grounding According to NEC, ANSI/NFPA 70

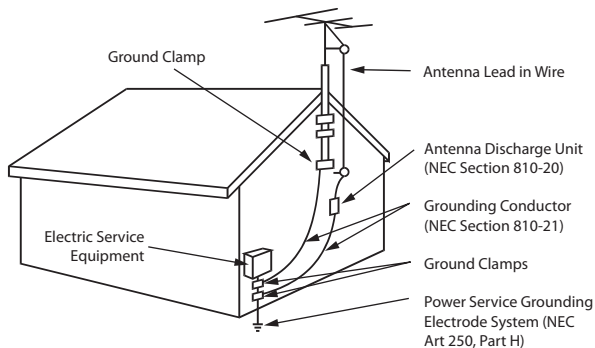

22. Cleaning

When cleaning, unplug the power cord and wipe gently with a soft cloth to prevent scratching. Do not spray water or other liquids directly on the TV as electric shock may occur. Do not clean with chemicals such as alcohol, thinners or benzene.

23. Transporting Product

Make sure the TV is turned off and unplugged and that all cables have been removed. It may take two or more people to carry larger TVs. Do not press against or put stress on the front panel of the TV.

24. Ventilation

Install the TV where there is proper ventilation. Do not install in a confined space such as a bookcase. Do not cover the TV with cloth or other materials (e.g., plastic) while it is plugged in. Do not install in excessively dusty places.

25. If you smell smoke or other odors coming from the TV or hear strange sounds, unplug the power cord, and contact an authorized service center.

26. Keep the product away from direct sunlight.

27. When mounting a TV on the wall, make sure that none of the electrical cabling bears any of the weight of the TV. Install in accordance with the manufacturer's instructions.

28. Do not install this product on a wall if it could be exposed to oil or oil mist. This may damage the product and cause it to fall.

29. Do not allow an impact shock or any objects to fall into the product, and do not drop objects onto the screen.

30. Do not touch the ventilation openings, as they may become hot while the TV is operating. This does not affect the performance of the product or cause defects in the product.

31. Do not use high voltage electrical equipment near the TV (e.g., a bug zapper). This may result in product malfunction.

32. Dot Defect

This panel is an advanced product that contains millions of pixels. In a very few cases, you could see fine dots on the screen while you are viewing the TV. Those dots are deactivated pixels and do not affect the performance and reliability of the TV.

33. Generated Sound

“Cracking”: A cracking noise that occurs while the TV is on or when it is turned off is generated by plastic thermal contraction due to temperature and humidity. This noise is common for products where thermal deformation is required.

Electrical circuit humming/panel buzzing: A low level noise is generated from a high-speed switching circuit, which supplies a large amount of current to operate a product. It varies depending on the product. This generated sound does not affect the performance and reliability of the product.

34. If the TV feels cold to the touch, there may be a small “flicker” when it is turned on. This is normal; there is nothing wrong with the TV. Some minute dot defects may be visible on the screen, appearing as tiny red, green, or blue spots. However, they have no adverse effect on the TV's performance. Avoid touching the screen or holding your finger(s) against it for long periods of time. Doing so may produce some temporary distortion effects on the screen.

35. Displaying a still image for a prolonged period of time may cause image burn-in. Avoid displaying a fixed image on the TV screen for an extended length of time.

Table of Contents

| | | | |
|---|-------|--|---------|
| Safety Warnings | 2 | Cloning Procedures | 57–63 |
| Important Safety Instructions | 3–4 | Exporting a Clone File | 57 |
| Table of Contents | 5–6 | Importing a Clone File | 59 |
| Commercial Mode Overview | 7–12 | Cloud Configuration Tool Overview | 64–69 |
| Setup Checklist | 7 | Creating an FTG Configuration File | 64 |
| Pass-through Mode | 7 | File Manager Web Page Overview | 67 |
| FTG Mode | 9 | Channel Map Web Page Overview | 68 |
| Application Tuning Mode / Pro:Centric Direct | 10 | Installer Menu Web Page Overview | 69 |
| Determining the TV Operating Mode | 11 | IP Environment Setup | 70–83 |
| Pro:Centric Operation | 13–17 | Accessing the IP Environment Menu | 70 |
| Interactive Menu Features | 13 | Network Configuration | 70 |
| Interactive Menu Navigation | 13 | Pro:Centric Setup | 75 |
| Pro:Centric Java Application Setup | 15 | Portal Settings | 79 |
| Pro:Centric Direct HTML Application Setup | 16 | Media Share Setup | 81 |
| First Use Wizard | 18–19 | References | |
| Before You Begin | 18 | Updating TV/PTC Software using a USB Memory | |
| Initiate Configuration or Exit the First Use Wizard | 19 | Device | 84–85 |
| Basic Settings Wizard | 20–24 | Downloading Images or Icons using a USB Memory | |
| Solution Settings / EZ-Manager Wizard | 25–36 | Device | 86–88 |
| TV Configuration Options | 25 | Downloading a Hotel Video using a USB Memory | |
| Zones and Room Number Assignments | 26 | Device | 89–91 |
| Network Settings | 27 | Downloading a Pro:Idiom Media Key using a USB | |
| Configure Pro:Centric Settings | 30 | Memory Device | 92 |
| USB Configuration | 34 | Power Consumption Settings | 93 |
| Ez Download Utility | 37–41 | TV Aux Input Configuration | 94 |
| Before You Begin | 37 | Auto Input(s) Sensing Feature | 95–96 |
| Accessing and Using the Ez Download Utility | 37 | Restoring Factory Defaults on the TV(s) | 97 |
| Installer Menu | 42–53 | Using the TV's Zoning Features | 98–101 |
| Accessing the Installer Menu | 42 | Using Media Share Features | 102–103 |
| Navigating Within the Installer Menu | 43 | UT782V Rear and Side Jack Panels | 104 |
| Modifying Installer Menu Settings | 43 | External Speaker/Audio Line Out Specifications | 105 |
| Exiting the Installer Menu and Activating Settings | 43 | Expansion Interface Connector Specifications | 106 |
| Detailed Descriptions of Installer Menu Items | 46 | Installer Remote Control Typical Key Functions | 107 |
| Custom Master TV Setup | 54–56 | TLT Communication Parameters | 108–114 |
| Before You Begin | 54 | Troubleshooting | 115–116 |
| Clonable TV Setup Menu Features | 54 | General Troubleshooting | 115 |
| Custom Master TV Setup Procedure | 55 | Commercial Mode Check | 116 |

Notes

- Installer Menu content is intended for use primarily by qualified TV installation technicians.
- Refer to the applicable Owner's Manual and/or Easy Setup Guide for additional information on TV installation, specifications, maintenance, and safety instructions.
- Design and specifications subject to change without prior notice. This document provides examples of typical TV displays. Your displays may vary from those shown in this document.

Table of Contents (Cont.)

| | |
|--|-----|
| Glossary of Terms | 117 |
| Document Revision History / Open Source Software Notice | 118 |
| Back Cover | 119 |

This document describes how to set up UT782V Pro:Centric® TVs for Commercial Mode operation. LG commercial TV functionality is based on “ownership” of the Channel Map; that is, the Channel Map resides in the TV’s CPU or Protocol Translation Controller (PTC), or it resides in a Pro:Centric application or an external device from the solution provider.

These TV models support several different operational modes: LG’s Free-To-Guest (FTG) Mode via the TV CPU, Application Tuning Mode (ATM) with Pro:Centric application, or Pass-through Mode (default). In several operational modes (Pass-through, FTG Mode, and Application Tuning Mode), these TV models may also be externally controlled via Multiple Protocol Interface (MPI) or TV-Link Tuner (TLT) interface (RS-232C).*

Setup Checklist

Note: This document provides information specific to Commercial Mode operation. Refer to the Owner’s Manual and/or Easy Setup Guide for information on TV installation and hardware and cable connections.

Installation

- ___ Unpack TV and all accessories.
 - ___ Install batteries in the Installer Remote.
 - ___ Install TV on VESA mount or stand.
- Note:** It may be advisable to make all cable connections before installing on VESA mount or stand, as appropriate.

Cable Connections

- ___ Make all rear jack panel connections, as appropriate.

Commercial Mode Setup

- ___ Complete appropriate procedures as described in this document for Commercial Mode operation.

Hardware Connections

- ___ Install any additional hardware as appropriate to your institution, LAN, etc.

Pass-through Mode

This mode allows you to configure individual TVs for Pro:Centric and/or FTG Mode operation. This mode also allows external control via either the TV’s MPI port or TLT (RS-232C Control) port.

There are several methods for configuring individual TVs that are currently in Pass-through Mode: using one of the First Use Wizard options or using the Custom Master TV Setup procedure.

First Use Wizard

When the TV is in a factory default state, the First Use Wizard provides three guided setup options:

- Basic Settings: Configuration of basic settings, including language & location, network settings, etc.
- Solution Settings (default): EZ-Manager Wizard configuration for Pro:Centric operation.
- IP Environment Settings: Configuration of network settings, manual Pro:Centric settings, etc. via the IP Environment Menu.

See “First Use Wizard” on pages 18 to 19 for further information.

* MPI is an LG proprietary control protocol; you will need to sign a non-disclosure agreement (NDA) in order to obtain the MPI interface, timing, and syntactical command set specification.

Commercial Mode Overview (Cont.)

Custom Master TV Setup

The Custom Master TV Setup procedure enables you to create a customized Master TV Setup for Pass-through Mode or FTG Mode configuration purposes. Use the Installer Remote to configure Installer Menu items as required for TV operation and set up TV features (Channels, Picture, Sound, etc.). See “Custom Master TV Setup” on pages 54 to 56 for detailed information.

Installer Menu

To create a Master TV Setup, you will need to know how to access the commercial controller (PTC) Installer Menu and make changes to the default values as required. If necessary, familiarize yourself with the Installer Menu and how to make and save changes. See pages 42 to 53 for information on accessing the Installer Menu and for detailed descriptions of the Installer Menu items. See also example below.

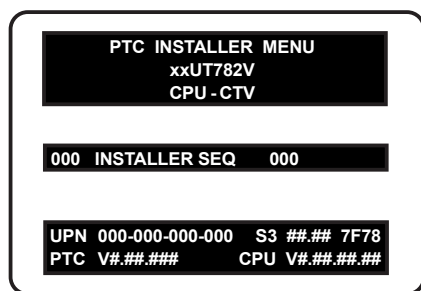

TV Setup Menus

On-screen setup menus control the features of the TV. Use the Installer Remote to access the TV setup menus, and set the TV features to the desired configuration for the end user. See examples below.

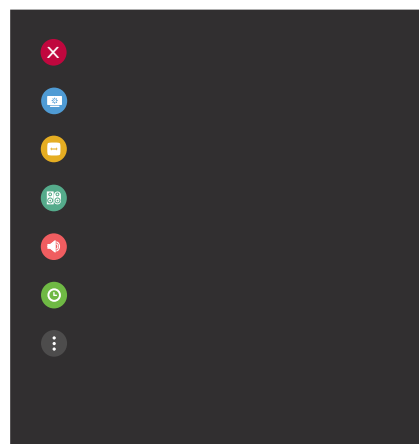

TV Setup Menus (Quick Settings)

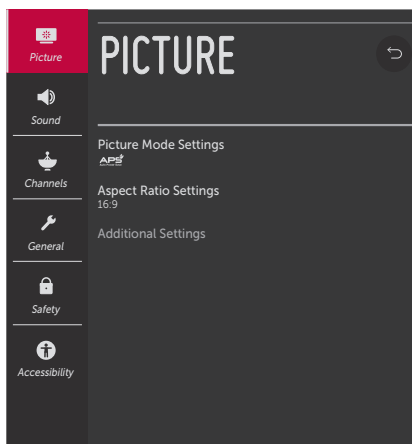

TV Setup Menus (Advanced Settings)

Cloning

Cloning refers to the process of using a Master TV Setup to configure a Target TV. The Master TV's clonable setup menu features should be configured as part of the Master TV Setup. If there are features in the Master TV's setup—channel icons or labels, digital font options, etc.—that are not set or that are set incorrectly, those features also will not be set or will be set incorrectly in the Target TVs. See pages 57 to 63 for detailed information on Clone (.tlx) files and cloning requirements and procedures.

External Control

Installer Menu item 030 EXTCTL/ACKMASK determines the availability of external control in accordance with the mode in which the TV is currently operating. See bullets below as well as Installer Menu item 030 description on page 48 for details.

- To control the TV using an external MPI control device, you must use the TV's MPI port for communication purposes.

Note: When the TV is in Pass-through/CPU-CTV Mode, item 030 is set to 0 or 1, and an MPI device functioning in “loop” mode is connected to the TV, the TV will go into MPI-EXT Mode, and TLT external control automatically will be blocked.

- To control the TV using an external TLT control device, you must use the TV's RS-232C port for communication purposes. See Reference section, “TLT Communication Parameters,” for further information.

FTG Mode

In this mode, the TV's CPU is configured with an FTG Channel Map, and the CPU controls and restricts the tuning operation of the TV based on this FTG Channel Map. The FTG Channel Map enables the decryption of each Pro:Idiom[®] encrypted channel and also provides logical channel mapping of physical RF channels (digital and analog), IP streams, and Aux inputs. In addition, in these models, depending on the types of channels included in the FTG Channel Map, FTG Mode also provides the option to select either logical or physical tuning (see notes below) during configuration.

Note: Logical channel mapping of physical RF channels eliminates dash tuning; for example, physical 19-3 can be mapped to logical channel 9. It also allows physical RF channels, IP streams, and Aux inputs to be listed in any order, not only in physical numeric ascending order. Physical channel tuning requires that you include the dash when direct entering RF channel numbers and Aux inputs (the latter designated by 130-0 through 137-0).

Note: Physical channel tuning is not available when IP channels are included in the FTG Channel Map.

FTG Mode Features

This mode provides the following features:

- Logical or physical channel tuning of physical RF channels and Aux inputs.
- Logical channel tuning of IP streams.
- Mapping of RF channels with minor (program) numbers up to 999.
- FTG Channel Map of up to 600 channels.
- Start Channel set for RF, Aux input, or IP delivered content.
- Pro:Centric data delivery over RF or IP.

Commercial Mode Overview (Cont.)

- TV Zoning (including channel restrictions by Zone) and Wi-Fi Zoning options for location-specific configurations.
- External control via either the TV's MPI port or the TV's TLT port (RS-232C Control).

LG's Cloud Configuration Tool enables you to create an FTG Configuration (.tlx) file, which may be used to configure the CPU for FTG Mode. Configuration utilities enable you to create/edit an FTG Channel Map and configure FTG Installer Menu settings. You can also create a Clone (.tlx) file from a Master TV Setup that may be used to configure the CPU for FTG Mode.

Note: TV Zoning and Wi-Fi Zoning features are supported via ".tlx" file. See Reference section, "Using the TV's Zoning Features," for further information.

In this mode, the TV's CPU must be configured with an FTG Channel Map and FTG Installer Menu settings using one of the following processes:

- Local: Configure an individual UT782V TV via its USB port using a USB memory device / ".tlx" file. The file may be either a Clone file (see "Cloning Procedures" on pages 57 to 63) or an FTG Configuration file (see "Cloud Configuration Tool Overview" on pages 64 to 69).
- Remote: Configure all UT782V TVs at the site using a Pro:Centric server head end device (Example: PCS500R). Refer to the **Pro:Centric Server Admin Client User Guide** for further information.

While the TV is in FTG Mode:

- Users can still access the Installer Menu using an LG Installer Remote; however, all Installer Menu items will be read-only.
- FTG Mode configuration changes must be made using a ".tlx" file (typically edited in the Cloud Configuration Tool). Channel Map and Installer Menu configuration utilities enable you to make changes, respectively, to the FTG Channel Map and FTG Installer Menu settings as necessary. See information on local configuration in this document, or refer to documentation for the server for information on remote management.
- If it becomes necessary to restore the TV to Pass-through Mode, there are several options that will enable you to do so. See Reference section, "Restoring Factory Defaults on the TV(s)," for further information.

Pages 64 to 69 provide overviews of the utilities that comprise the Cloud Configuration Tool. Refer to the **Cloud Configuration Tool User Guide** for further information on the Cloud Configuration Tool.

Remote Management

When the TV is configured for FTG Mode, remote management of the FTG Channel Map and FTG Installer Menu settings is provided by a Pro:Centric server, via a Clone/Configuration (.tlx) file loaded on the Pro:Centric Admin Client. See the **Pro:Centric Server Admin Client User Guide** for further information.

External Control

Installer Menu item 030 EXTCTL/ACKMASK determines the availability of external control in accordance with the mode in which the TV is currently operating. See bullets below as well as Installer Menu item 030 description on page 48 for details. External control is prohibited by default in FTG Mode. Set item 030 to allow external control via (only) one of the applicable ports.

- To control the TV using an external MPI control device, you must use the TV's MPI port for communication purposes.
- To control the TV using an external TLT control device, you must use the TV's RS-232C port for communication purposes. See Reference section, "TLT Communication Parameters," for further information.

Application Tuning Mode / Pro:Centric Direct

In Application Tuning Mode, the TV's Channel Map resides in an application, such as LG's Pro:Centric Direct HTML application. With Pro:Centric Direct, the Channel Map is created in the Pro:Centric server's Admin Client web editor, and the tuning operation of the TV is controlled and restricted based on this Pro:Centric Direct Channel Map.

Application Tuning Mode with the Pro:Centric Direct HTML application provides the following features:

- Decryption of each Pro:Idiom[®] encrypted channel.
- Logical channel tuning of physical RF channels (digital and analog) and IP streams.
- Mapping of RF channels with minor (program) numbers up to 999.
- Start Channel set for RF or IP delivered content.
- Pro:Centric data delivery over RF or IP.
- TV Zoning (Installer Menu items only) and Wi-Fi Zoning options for location-specific configurations.
- External control via either the TV's GAME CONTROL/MPI port or the TV's TLT port (RS-232C Control).

You must use the Pro:Centric Direct Admin Client / Channel Map configuration utility to create the Pro:Centric Direct Channel Map, define channel attributes, and set the Start Channel. Refer to the ***Pro:Centric Direct Admin Client User Guide*** for further information.

Note: TV Zoning and Wi-Fi Zoning features are supported via ".tlx" file—typically a Clone (.tlx) file that has been created from a Master TV Setup. See Reference section, "Using the TV's Zoning Features," for further information.

While the TV is in Application Tuning Mode:

- Users can still access the Installer Menu using an LG Installer Remote; however, all Installer Menu items will be read-only.
- While it is possible to update a TV's Installer Menu and/or Setup Menu settings locally using a USB memory device / Clone (.tlx) file, any Pro:Centric Direct configuration changes are typically made remotely via the Pro:Centric server / Pro:Centric Direct Admin Client. The Admin Client's Channel Map configuration utility enables you to create and edit the Pro:Centric Direct Channel Map, while the TV Configuration utility (in conjunction with a Clone [.tlx] file loaded on a server carousel) enables you to make changes to TV Installer Menu and/or Setup Menu settings.
- If it becomes necessary to restore the TV to Pass-through Mode, it is possible to do so. See Reference section, "Restoring Factory Defaults on the TV(s)," for further information.

Refer to the ***Pro:Centric Direct Admin Client User Guide*** for further information on configuration and management via the Pro:Centric Direct Admin Client.

External Control

Installer Menu item 030 EXTCTL/ACKMASK determines the availability of external control in accordance with the mode in which the TV is currently operating. See bullets below as well as Installer Menu item 030 description on page 48 for details. External control is prohibited by default in Application Tuning Mode. Set item 030 to allow external control via (only) one of the applicable ports.

- To control the TV using an external MPI control device, you must use the TV's MPI port for communication purposes.

Commercial Mode Overview (Cont.)

- To control the TV using an external TLT control device, you must use the TV's RS-232C port for communication purposes. See Reference section, "TLT Communication Parameters," for further information.

Determining the TV Operating Mode

To determine the operating mode of the TV, press **MENU SETTINGS** on the Installer Remote. The menu displayed depends on the operating mode. See examples below.

If the Function Menu appears, the TV is in a mode (FTG, ATM, PPV, etc.) that does not allow the end user to change the fundamental TV setup. If the TV setup menus (Quick Settings) appear, the TV is in Pass-through Mode.

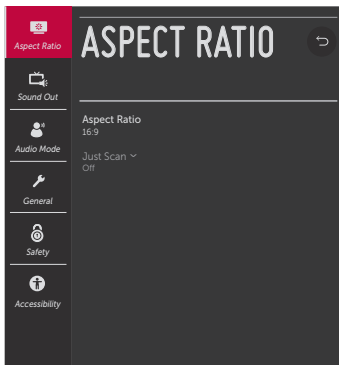

Function Menu

Indicates the TV is not in Pass-through Mode. While the TV is in this mode, Installer Menu settings can be accessed as read-only.

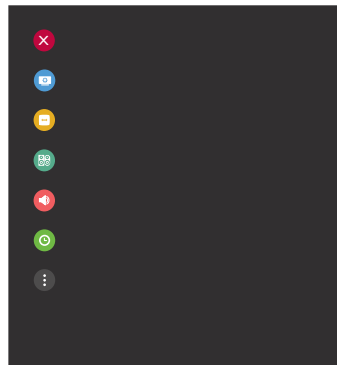

TV Setup Menus

Shows that the TV is in Pass-through Mode.

These TV models support LG's Pro:Centric Java application, as well as the Pro:Centric Direct HTML application. Only one application may be implemented at a time. The following sections provide an overview of the application features and functionality.

Interactive Menu Features

Both the Pro:Centric Java (GEM) application and the Pro:Centric Direct HTML application enable guests to locate and select television entertainment, check the daily weather, view amenities, etc. via custom portal interactive menus. The Pro:Centric Java application provides multiple templates for portal interactive menus, while the Pro:Centric Direct HTML application, in addition to providing multiple templates for portal interactive menus, also enables you to custom-create portal and application content.

Pro:Centric application features include:

- Portal and information screens/pages (including a "Welcome" page) that include branding logos.
- An optional customized user interface (custom "skins").
- Billboards and points-of-interest maps that can be customized to focus on amenities, local attractions and businesses, restaurants, news, events, etc.
- An optional Weather billboard that includes a local radar map, current conditions, and a four day forecast.
- An interactive channel guide that provides a channel list with channel icons. An electronic program guide (EPG) is an optional feature that displays up to three days of programming information viewable by channel and time.
- Video spooling that enables delivery of video files to guest TVs for promotion and information purposes.

In addition to the those indicated above, the Pro:Centric Direct HTML application also offers the following features:

- Optional messaging features, including notices, ticker text, and ad banners.
- Additional media support, specifically music accompaniment, for portal displays.
- An optional flight information display.

For each Pro:Centric application, an Admin Client web editor/content wizard is provided for customer configuration of portal content. The Pro:Centric Direct Admin Client features the Pro:Centric Direct Project Editor, which provides design tools (including templates) that enable customization of all portal pages. Please contact your LG service representative for further information.

Note: Customized content is typically defined by the service integrator and/or installation site administrators. LG does not provide site-specific content.

Interactive Menu Navigation

An LG Pro:Centric-capable TV remote control provides access to both interactive menus and regular TV features. Press **PORTAL** on the remote to access the interactive menus.

Interactive menu options may vary, depending on Pro:Centric features enabled for the site and/or customized content. The following examples show typical portal interactive menus.

Pro:Centric Operation (Cont.)

Example: Pro:Centric Java (GEM) Application Portal

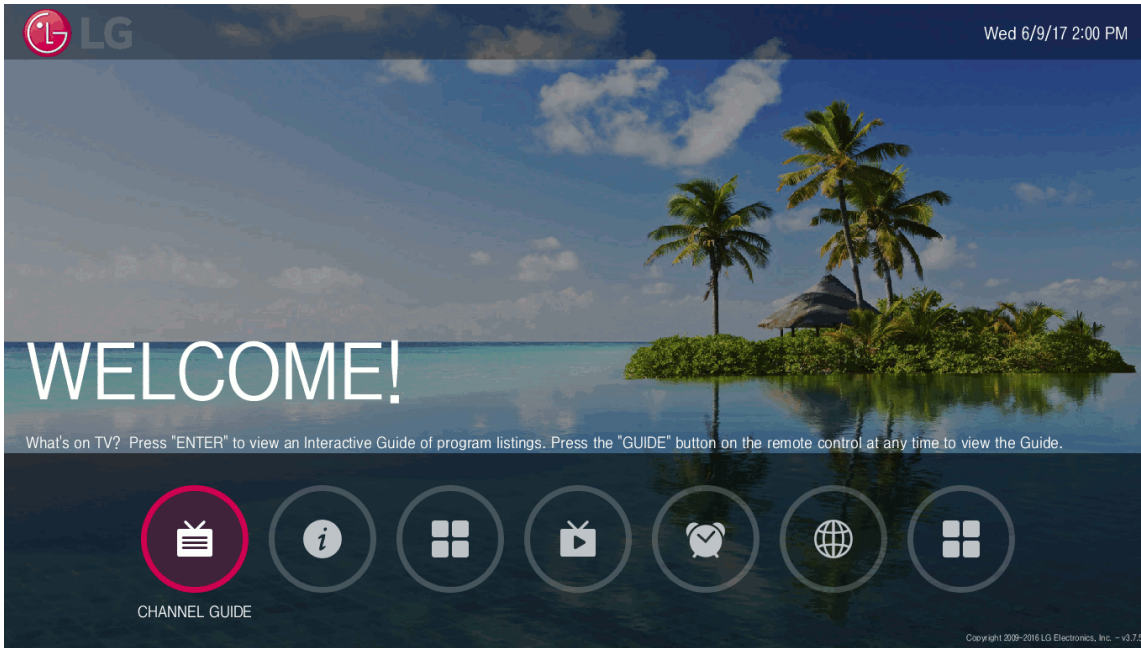

Example: Pro:Centric Direct HTML Application Portal

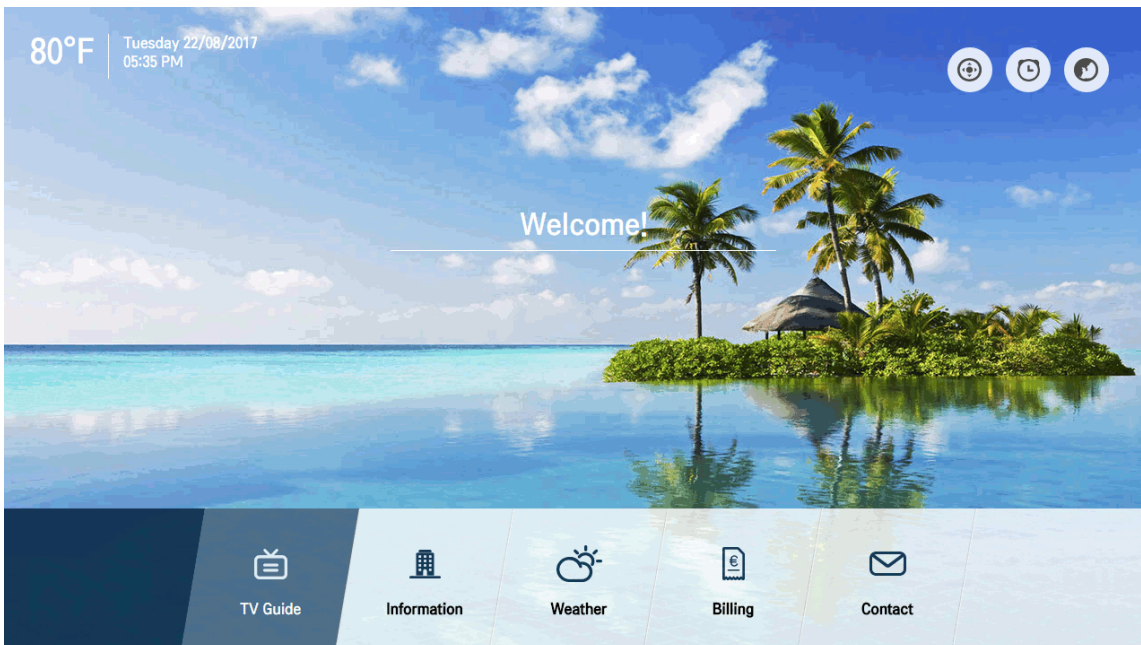

Pro:Centric Java Application Setup

The Pro:Centric Java (GEM) application operates in conjunction with FTG and PPV Modes. This section provides an overview of the setup required for the Pro:Centric features. Administration and management options for the Pro:Centric server are described in detail in the **Pro:Centric Server Admin Client User Guide**. This document describes only those settings that must be specified on the TVs to enable Pro:Centric remote management and/or the Pro:Centric Java application.

- Remote management (TV E-Z Installation): The Pro:Centric Admin Client provides remote management facilities for downloading boot logo image and software updates as well as facilities for downloading a Clone/Configuration (.tlx) file for FTG Mode configuration.
- Pro:Centric Java application: The application comprises the Pro:Centric interactive menus/features described on page 13. Pro:Centric application settings are managed via the Pro:Centric Admin Client for the Java application.

The Pro:Centric remote management facilities and application download are based on Installer Menu item settings that are used to set up the TV's Pro:Centric features. The Installer Menu / Pro:Centric server settings can be configured using one of the methods described below.

TV in Factory Default State

When the TV is in a factory default state, LG's First Use Wizard provides automated or manual options for configuring the TV's Pro:Centric server settings. See "First Use Wizard" on pages 18 to 19 for further information. The First Use / EZ-Manager Wizard (i.e., Solution Settings) also provides a USB configuration option that enables you to configure a TV for FTG Mode using a Clone/Configuration (.tlx) file stored on a USB memory device. The ".tlx" file incorporates FTG Installer Menu settings, including Installer Menu items 098 PRO:CENTRIC and 119 DATA CHANNEL, which are used to set up the TV's Pro:Centric features.

TV in Pass-through Mode

If the First Use Wizard has been exited and the TV is in Pass-through Mode, use one of the following options, in accordance with the Pro:Centric server output:

- RF output: Set Installer Menu items 098 PRO:CENTRIC and 119 DATA CHANNEL to the appropriate values. See Installer Menu information on pages 42 to 53 for further details. Also, as necessary, refer to "Custom Master TV Setup" on pages 54 to 56 and/or cloning information on pages 57 to 63.
- RF or IP output: Configure the appropriate Pro:Centric server settings in the IP Environment / Pro:Centric Menu. See "Accessing the IP Environment Menu" on page 70 and "Pro:Centric Setup" on pages 75 to 78 for further information.

Note: When the TV is in either Pass-through Mode or FTG Mode, you can also leave Installer Menu item 119 DATA CHANNEL set to its default value (255) to enable the TV's Data Channel Auto Search feature to set the DATA CHANNEL value. See item 119 description on page 52 for additional information.

TV in FTG Mode

If the TV is already in FTG Mode, use the Cloud Configuration Tool to update Installer Menu items #98 Pro:Centric and #119 Data Channel (along with their affiliated fields). Then, transfer the FTG Installer Menu settings to the TV. Refer to the FTG Mode overview on pages 9 to 10 for further information on FTG Mode operation and configuration. Also, see note above regarding the option to use the TV's Data Channel Auto Search feature to set the DATA CHANNEL value.

Pro:Centric Operation (Cont.)

Pro:Centric Direct HTML Application Setup

The Pro:Centric Direct HTML application operates only in Application Tuning Mode (ATM). This section provides an overview of the setup required for the Pro:Centric Direct features. Administration and management options for the Pro:Centric server are described in detail in the **Pro:Centric Direct Admin Client User Guide**. This document describes only those settings that must be specified on the TVs to enable Pro:Centric remote management and/or the Pro:Centric Direct HTML application.

- Remote management (TV E-Z Installation): The Pro:Centric Direct Admin Client provides remote management facilities for downloading boot logo image and software updates as well as facilities for downloading Installer Menu configuration updates via Clone (.tlx) file to the TVs at the property.
Note: The Pro:Centric Direct Channel Map is created and maintained in the Pro:Centric Direct Admin Client. Thus, any Clone file that is loaded on the server for remote configuration may only contain Installer Menu and/or Setup Menu profiles.
- Pro:Centric Direct HTML application: The application comprises the Pro:Centric interactive menus/features described on page 13. Pro:Centric Direct application settings are managed via the Pro:Centric Direct Admin Client.

The Pro:Centric remote management facilities and application download are based on Installer Menu item settings that are used to set up the TV's Pro:Centric features. The Installer Menu / Pro:Centric server settings can be configured using one of the methods described below.

TV in Factory Default State

When the TV is in a factory default state, LG's First Use Wizard provides automated or manual options for configuring the TV's Pro:Centric server settings. See "First Use Wizard" on pages 18 to 19 for further information. The First Use / EZ-Manager Wizard (i.e., Solution Settings) also provides a USB configuration option that enables you to configure the TV's Installer Menu settings using a Clone (.tlx) file stored on a USB memory device. Installer Menu items 098 PRO:CENTRIC and 119 DATA CHANNEL are used to set up the TV's Pro:Centric features.

TV in Pass-through Mode

If the First Use Wizard has been exited and the TV is in Pass-through Mode, use one of the following options, in accordance with the Pro:Centric server output:

- RF output: Set Installer Menu items 098 PRO:CENTRIC and 119 DATA CHANNEL to the appropriate values. See Installer Menu information on pages 42 to 53 for further details. Also, as necessary, refer to "Custom Master TV Setup" on pages 54 to 56 and/or cloning information on pages 57 to 63.
- RF or IP output: Configure the appropriate Pro:Centric server settings in the IP Environment / Pro:Centric Menu. See "Accessing the IP Environment Menu" on page 70 and "Pro:Centric Setup" on pages 75 to 78 for further information.

Note: When the TV is in either Pass-through Mode or Application Tuning Mode, you can also leave Installer Menu item 119 DATA CHANNEL set to its default value (255) to enable the TV's Data Channel Auto Search feature to set the DATA CHANNEL value. See item 119 description on page 52 for additional information.

TV in Application Tuning Mode

If the TV is already in Application Tuning Mode, use a Master TV of the same model to create and export a Clone (.tlx) file with the desired settings for Installer Menu items 098 PRO:CENTRIC and 119 DATA CHANNEL. Then, transfer (import) the Clone file to the Target TV. Refer to the Application Tuning Mode / Pro:Centric Direct overview on page 10 for further information on Pro:Centric Direct operation and configuration. To transfer the Clone file remotely, use the appropriate utilities in the Pro:Centric Direct Admin Client to upload the Clone file to the Pro:Centric server and set up its distribution to the Target TV(s) at the site. See also note above regarding the option to use the TV's Data Channel Auto Search feature to set the DATA CHANNEL value.

First Use Wizard

Note: After it is turned ON, the TV begins an initialization process, and it may take several minutes for the First Use Wizard to appear.

LG's First Use Wizard, comprising multiple configuration options, will appear on the screen each time the TV is turned ON, until one of its configuration methods has been completed or the wizard is exited. Use the Installer Remote to make selections and complete each step.

- **Basic Settings:** Initiates the Basic Settings Wizard, which enables you to select basic TV settings, including the TV's language and location, and run Channel Tuning. It also allows you to configure the TV's network settings, as well as custom portal settings, if desired. See "Basic Settings Wizard" on pages 20 to 24 for further information.
- **Solution Settings (default):** Initiates the EZ-Manager Wizard. The primary purpose of the EZ-Manager Wizard is to guide you through the process (automated or manual) of configuring the essential Installer Menu items for Pro:Centric operation.

While the EZ-Manager Wizard is intended primarily for Pro:Centric-related configuration, the wizard also offers Zoning and network configuration options and, in addition, enables you to access the TV Manager / USB download options as part of the configuration process, if desired, to perform USB configuration and/or update functions. See "Solution Settings / EZ-Manager Wizard" on pages 25 to 36 for further information.

- **IP Environment Settings:** Enables you to access the IP Environment Menu to set up network features of the TV, including Pro:Centric and/or Media Share features. See "IP Environment Setup" on pages 70 to 83 for further information.



Caution: Do NOT unplug the TV power cord or remove the antenna cable or, if applicable, the LAN cable during the configuration process, as doing so will interrupt the current step and may corrupt the configuration data.

Before You Begin

- If you plan to create a customized Master TV Setup using the procedure described on pages 54 to 56, be sure to exit the LG First Use Wizard in order to avoid setup conflicts or setting modes that may cause unintended behavior or restrict the custom setup procedure. See also "Initiate Configuration or Exit the First Use Wizard" on the following page.
- If it has been completed or exited and therefore does not display, the First Use Wizard can be reactivated; however, this requires that you restore the TV to a factory default condition. See Reference section, "Restoring Factory Defaults on the TV(s)," for further information.
- If you would like to enable the SoftAP and/or Beacon Media Share features or select pre-loaded / Smart Launcher applications on a TV that will eventually be configured for FTG Mode, you will need to use the IP Environment Menu to do so before the TV is configured for FTG Mode. You can access the IP Environment Menu from the First Use Wizard or from the Installer Menu. See "Initiate Configuration or Exit the First Use Wizard" on the following page for information on accessing the IP Environment Menu from the First Use Wizard, and refer to "IP Environment Setup" on pages 70 to 83 for detailed information on the IP Environment Menu (as well as information on accessing the IP Environment Menu from the Installer Menu). See also "Custom Master TV Setup" on pages 54 to 56, as necessary.

Initiate Configuration or Exit the First Use Wizard

The Welcome screen provides a brief introduction to the First Use Wizard.

Note: The Welcome screen is allotted a time frame of 10 seconds, after which the Solution Settings / EZ-Manager Wizard proceeds automatically. If a Pro:Centric server is configured on the system/network and if no location-specific settings are required in the TV, for example, TV Zone, Wi-Fi Zone, Label, and/or Room Number settings, from this point, the EZ-Manager Wizard can proceed through each of the configuration steps with no further user interaction.

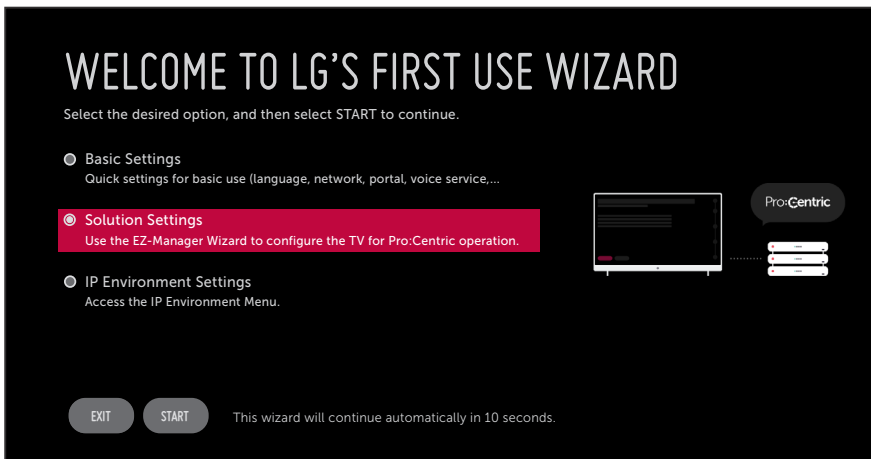

Use the arrow keys on the Installer Remote to select the desired option in the Welcome screen:

- To proceed with the Basic Settings Wizard, select/highlight **Basic Settings**, and then press **OK**. Then, select **START** and press **OK** to continue. See “Basic Settings Wizard” on pages 20 to 24 for further information.
- To proceed with the EZ-Manager Wizard, select/highlight **Solution Settings**, and then press **OK**. Then, select **START** and press **OK** to continue. See “Solution Settings / EZ-Manager Wizard” on pages 25 to 36 for further information.
- To access the IP Environment Menu, select/highlight **IP Environment Settings**, and then press **OK**. Then, select **START** and press **OK** to continue. See “IP Environment Setup” on pages 70 to 83 for further information.
- To exit the First Use Wizard, select/highlight the **EXIT** button at the bottom of the screen, and then press **OK**. In the exit confirmation screen, select **EXIT**, and then press **OK** once more on the Installer Remote.

Note: If you exit the First Use Wizard from the Welcome screen, no configuration will be performed and all Installer Menu items will retain their default values, including Installer Menu item 119 DATA CHANNEL. The default DATA CHANNEL setting (255) means that the Pro:Centric remote management feature on this TV will be activated if a Pro:Centric server is installed and the Data Channel value is set during a Data Channel Auto Search (see item 119 description on page 52 for additional information). If you actually would like to disable the Pro:Centric feature, both the EZ-Manager Wizard and the IP Environment Menu provide an option to do so, and/or you may disable Pro:Centric by setting the value of Installer Menu item 119 to 0.

Basic Settings Wizard

This section describes the configuration options available when you select “Basic Settings” from the First Use Wizard / Welcome screen. You can select the “BACK” button, where available, to check previous settings, as necessary.

Note: Each Basic Settings Wizard step is allotted a 10-second time frame after which the wizard proceeds automatically. If default settings are appropriate, the wizard can proceed through each of the configuration steps with no further user interaction. If you turn OFF the TV while the wizard is in progress, when you turn the TV back ON, the First Use Wizard / Welcome screen will be displayed. You will then have the opportunity to (re)initiate the desired configuration process.

Note: To exit the wizard at any time, use the arrow keys on the Installer Remote to select/highlight the **X** button at the top right of the screen, and then press **OK**. In the exit confirmation screen, select **EXIT**, and then press **OK** once more on the Installer Remote.

1. In the Language & Location screen, use the arrow keys on the Installer Remote to select/highlight each appropriate field in turn—Language or Time Zone—and then press **OK**. Then, use the up/down arrow keys to select the applicable value from the drop-down list of options for the selected field. When you are ready to continue, use the arrow keys on the Installer Remote to select **NEXT**, and then press **OK**.

Note: The Country field is inaccessible/grayed out because these models are only available in the US. Also, if you allow the wizard to progress without specifying data in this screen, the time zone will be set for “New York” (Eastern Standard Time).

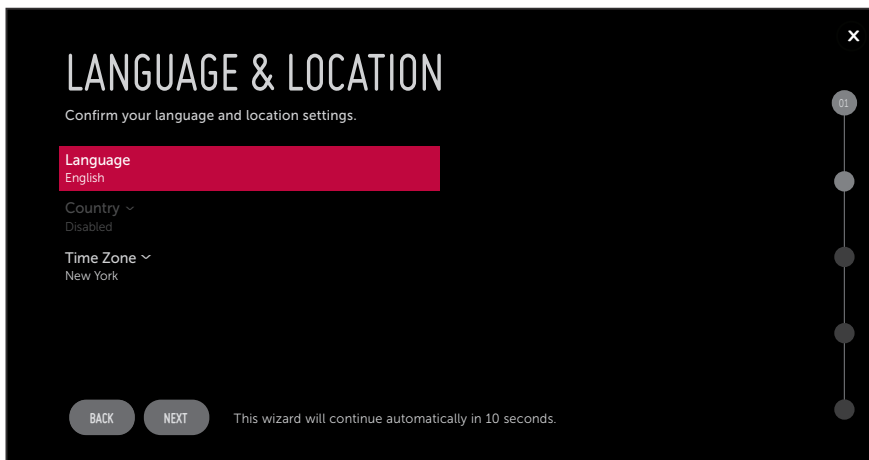

2. The next screen enables you to configure the network settings of the TV. Refer to the appropriate subsection(s) below for information on configuring the wired and/or wireless connection(s) between the TV and the network. When you are ready to continue, use the arrow keys on the Installer Remote to select **NEXT**, and then press **OK**.

Note: If desired, you can configure both wired and wireless connections to the Local Area Network (LAN). However, note that a wired connection is always prioritized over a wireless connection. That is, if an Ethernet cable is connected between the network and the TV’s LAN port, the TV will default to the wired connection. If the Ethernet cable is removed, the TV will then attempt to establish the wireless connection. Whenever the Ethernet cable is reconnected to the TV’s LAN port, the TV will re-establish the wired connection.

(Continued on next page)

(Continued from previous page)

Note: If an Ethernet cable is not currently connected between the TV and the network and you do not want to configure/complete configuration of network settings at this time, you can select/highlight **SKIP**, and press **OK** on the Installer Remote to continue to the next step.

Configure a Wired Network Connection

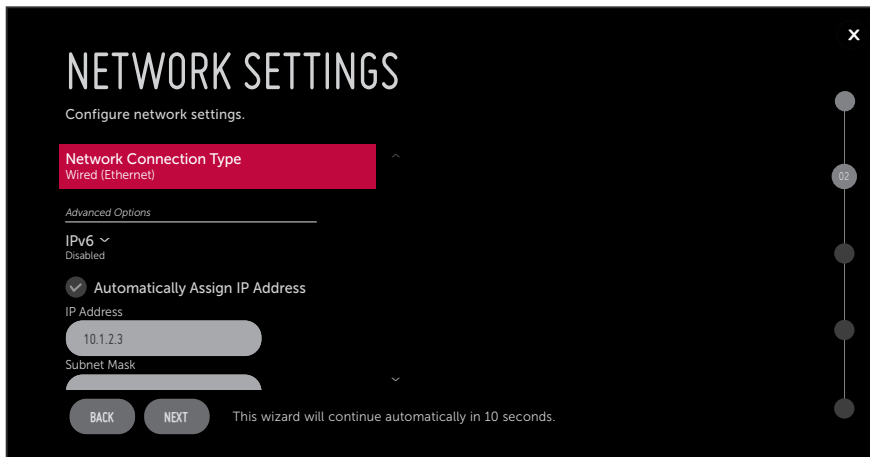

- If not already done, connect the appropriate cable between the TV and the network.
- Make sure the **Wired (Ethernet)** option is selected in the Network Connection Type field, and then press **OK** on the Installer Remote.
- By default, the TV uses DHCP, and if a LAN is detected, the TV will request an IP address from the DHCP server on the network. If the TV is able to connect to the network, the network configuration data will be displayed on the screen as shown in the example above.
If the network is not configured for DHCP, or if you want to enable/disable IPv6 or specify static IP configuration data (applicable only for IPv4), continue with steps (d) and/or (e), respectively.
- (Optional) To enable IPv6, select/highlight the IPv6 field and press **OK**. Then, select **Enabled** from the drop-down list of options.
- (Optional / IPv4 only) If required, you can edit the IP data for this TV as follows:
 - De-select the “Automatically Assign IP Address” checkbox under “Advanced Options.”
 - For each data entry field: Use the arrow keys on the Installer Remote to select the field and press **OK**. You can use the number keys on the Installer Remote to direct enter numeric values or use the arrow keys to select the appropriate characters from the pop-up virtual keyboard displayed at the bottom of the screen. When you are done, select **Enter** from the virtual keyboard, and then press **OK** on the Installer Remote.

Note: You must use the dot “.” key from the virtual keyboard to separate each octet of an IP address.

(Continued on next page)

Basic Settings Wizard (Cont.)

(Continued from previous page)

Configure a Wireless (Wi-Fi) Network Connection

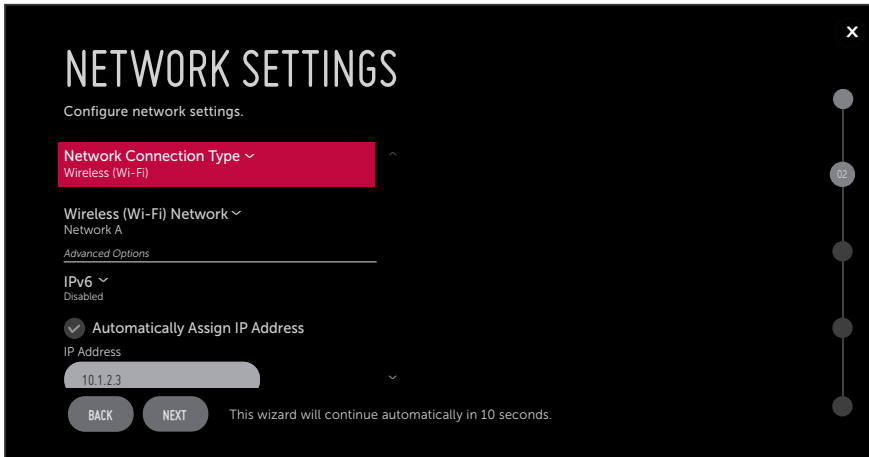

- Select/highlight the Network Connection Type field, and press **OK** on the Installer Remote. Then, use the Up/Down arrow keys to select/highlight **Wireless (Wi-Fi)**, and press **OK** once more.
- Select/highlight the Wireless (Wi-Fi) Network field, and press **OK** on the Installer Remote. Then, use the Up/Down arrow keys to select/highlight the desired access point from the drop-down list of available options, or select the “Hidden Network” option at the bottom of the list to specify an access point with a hidden SSID. Press **OK** once more.

Note: Make sure you have the network security password—at least eight, but no more than 32 characters—or PIN available if you are attempting to connect to a secured network. If you would like to add an access point with a hidden SSID, you will need to direct enter the SSID—up to 32 characters—of the access point.

- Follow the on-screen instructions to complete the appropriate network configuration. Use the Installer Remote to navigate between fields and make entries, etc.

Note: As with a wired connection, you will have the option to specify static IPv4 configuration data for this network connection. Once the initial connection is established, you can de-select the “Automatically Assign IP Address” checkbox under “Advanced Options,” and then modify the IP data, as required. See step (e) of the wired connection procedure above for further information on the data entry fields.

- (Optional) To enable IPv6, select/highlight the IPv6 field and press **OK**. Then, select **Enabled** from the drop-down list of options.
- Once the wireless network configuration is complete, use the arrow keys on the Installer Remote to select **CONNECT**, and then press **OK** on the Installer Remote to continue.

Note: The “CONNECT” button becomes a “NEXT” button once the connection is successful.

(Continued on next page)

(Continued from previous page)

3. In the Portal Settings screen, you can specify the Portal Mode and the Portal Auto Start status for this TV. Use the arrow keys on the Installer Remote to select/highlight each appropriate field in turn—Portal Mode or Portal Auto Start—and then press **OK**. Then, use the up/down arrow keys to select the applicable value from the drop-down list of options for the selected field. When you are ready to continue, use the arrow keys on the Installer Remote to select **NEXT**, and then press **OK**.

Note: Customizable portal settings are for TVs that will NOT be configured for Pro:Centric operation. If the “Customizable Portal” option is selected in the Portal Mode field, you will be redirected to the IP Environment / Portal Settings Menu when this wizard is complete, so that you can configure the custom portal settings. The Portal Auto Start status is either “On” (display the portal when the TV is turned ON) or “Off” (do not display the portal when the TV is turned ON).

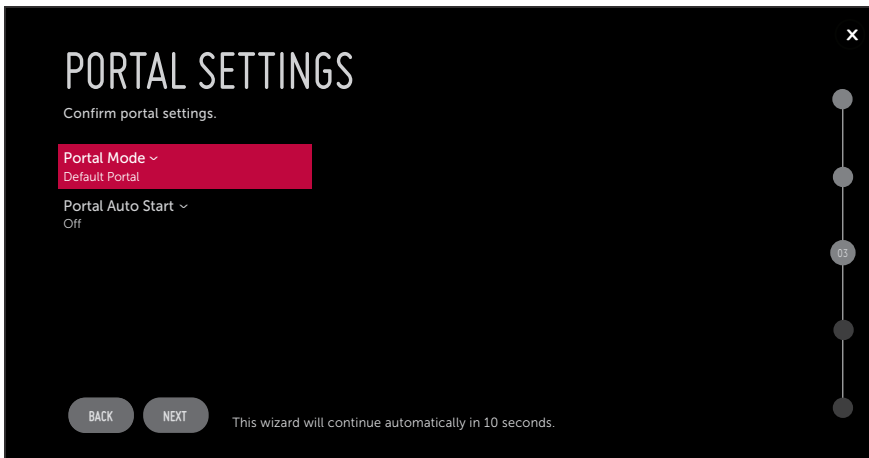

4. In the Voice Service Coverage screen, use the arrow keys on the Installer Remote to select/highlight each appropriate field in turn—LG Service Country or Service Area Zip Code—and then press **OK**. Then, use the up/down arrow keys to select the applicable value from the drop-down list of options for the selected field. When you are ready to continue, use the arrow keys on the Installer Remote to select **NEXT**, and then press **OK**.

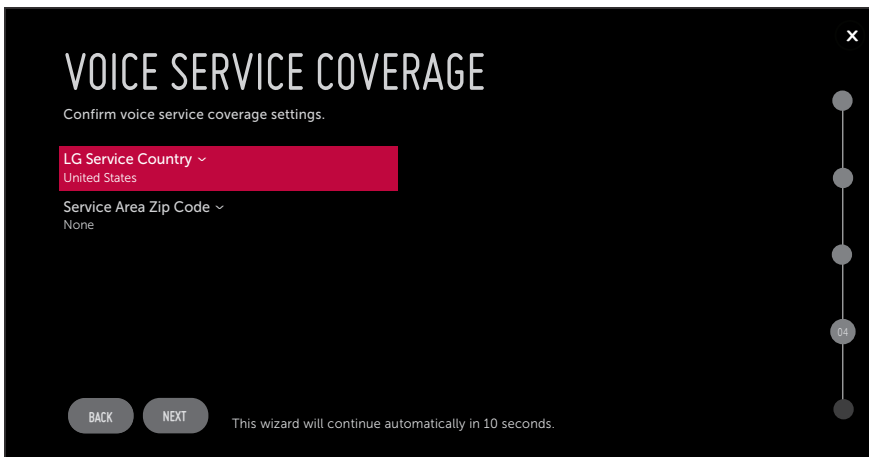

(Continued on next page)

Basic Settings Wizard (Cont.)

(Continued from previous page)

5. The Channel Tuning screen is the final step of the Basic Settings Wizard.

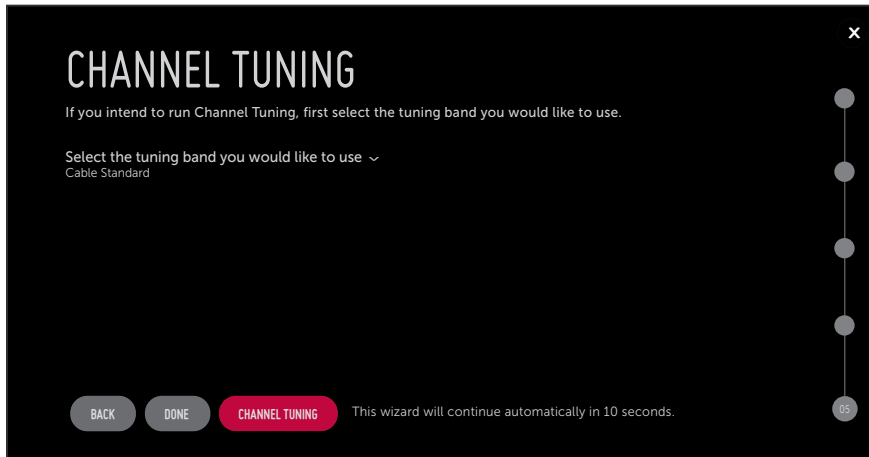

- If you would like to initiate an automated channel scan (i.e., a search for all available digital and analog channels), use the arrow keys on the Installer Remote to select the RF tuning band field, and select the appropriate option. Then, press **OK**. Next, select the **CHANNEL TUNING** button at the bottom of the screen, and press **OK**.

Tuning progress will be shown in a new Channel Tuning screen. The scan typically takes a few minutes. When the channel scan is complete, the TV will launch the IP Environment Menu. See additional information below.

- If you would like to continue with the basic TV setup without running Channel Tuning, select the **DONE** button at the bottom of the screen, and press **OK**. The TV will launch the IP Environment Menu. See additional information below.

As indicated above, the IP Environment Menu is always launched after the Basic Settings Wizard is complete (and once Channel Tuning is finished, if applicable). If you selected the “Customized Portal” option in the Portal Settings screen, the IP Environment / Portal Settings Menu will be on display when the IP Environment Menu launches, and you can configure the portal, as desired. If you did not select “Customized Portal,” the IP Environment Menu launches with the Network Menu options on display (default IP Environment Menu launch scenario). See “IP Environment Setup” on pages 70 to 83 for further information on the options available in the IP Environment Menu.

This section describes the EZ-Manager Wizard that is initiated when you select “Solution Settings” from the First Use Wizard / Welcome screen.

Note: If the Pro:Centric server is configured on the system/network and if no location-specific settings are required in the TV, for example, TV Zone, Wi-Fi Zone, Label, and/or Room Number settings, you can simply turn ON the TV, and once initiated, the wizard will proceed through each of the configuration steps with no further user interaction.

Note: Select the “BACK” button, where available, to check previous settings, as necessary. Also note that if you turn OFF the TV while the wizard is in progress, when you turn the TV back ON, a “Diagnostics” screen will be displayed (see also note below).

Note: If any of the configuration steps fails, you will see a “Diagnostics” screen with an indication of the failure. You will then have the opportunity to reinitiate the configuration process from the previous screen or exit the EZ-Manager Wizard.

TV Configuration Options

In the TV Configuration Options screen, you can choose how to proceed with the configuration of this TV.



Note: If you intend to use the Zoning feature(s) on the TV for location-specific configuration purposes, select the ZONES & ROOM NUMBER option from this screen and set the appropriate TV Zone # and/or the Wi-Fi Zone # in the TV BEFORE you continue with additional configuration.

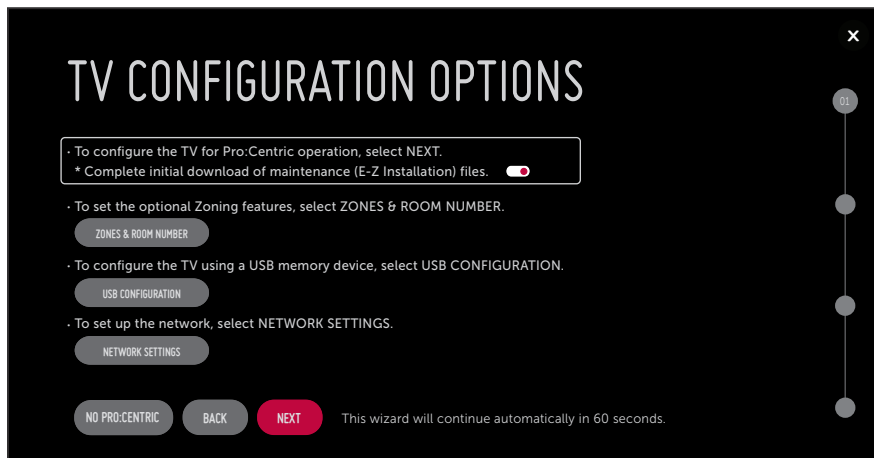

Note: If there is no user action in this screen within one minute, the wizard will automatically continue to the next configuration step. If you would like to exit the wizard at any time, use the arrow keys on the Installer Remote to select/highlight the **X** button at the top right of the screen, and then press **OK**. In the exit confirmation screen, select the appropriate “EXIT” option (see also note below), and then press **OK** once more on the Installer Remote.

Note: If you choose to exit the EZ-Manager Wizard from this point on, you will have the option to save any settings made by selecting **SAVE & EXIT** in the exit confirmation screen. Or, you can exit the wizard without saving any settings by simply selecting **EXIT** in the confirmation screen.

(Continued on next page)

Solution Settings / EZ-Manager Wizard (Cont.)

(Continued from previous page)

Use the Up/Down arrow keys on the Installer Remote to navigate between options on this screen.

- If you do not intend to install a Pro:Centric server on this system and you do not wish to use the wizard's Zoning, network settings, or USB configuration options, exit the wizard as follows: Select **NO PRO:CENTRIC**, and then press **OK**. This will disable the Pro:Centric feature of this TV (i.e., Installer Menu item 119 DATA CHANNEL will be set to 0) and exit the wizard. In the exit confirmation screen, select **EXIT**, and then press **OK** once more on the Installer Remote.

- To continue with Pro:Centric configuration, select **NEXT** (default) and press **OK** on the Installer Remote. See "Configure Pro:Centric Settings" on pages 30 to 34 for additional information.

Note: By default, any applicable maintenance (E-Z Installation) files are downloaded as part of the TV configuration. If you would like to skip the initial maintenance file download, select the (Yes) toggle button on the screen and press **OK** to change the value to (No). Maintenance files will still be downloaded during the daily update event, per Installer Menu item 121 setting.

- To set the Zoning feature(s) on the TV, select **ZONES & ROOM NUMBER**. See "Zones and Room Number Assignments" below for further information.
- To configure the network settings of the TV, select **NETWORK SETTINGS**. See "Network Settings" on pages 27 to 29 for further information.
- To access the TV Manager / USB download options, select **USB CONFIGURATION**. See "USB Configuration" on pages 34 to 36 for further information.

Zones and Room Number Assignments

You may complete one or more of the fields in the Zones, Label, and Room Number screen or leave them at their default settings (TV Zone and Wi-Fi Zone) or blank (Label and Room Number), as desired. However, if you intend to use either of the Zoning features—TV Zoning and/or Wi-Fi Zoning—on this TV, you **MUST** specify the appropriate values in the TV Zone and/or Wi-Fi Zone fields as described below. See Reference section, "Using the TV's Zoning Features," for further information.

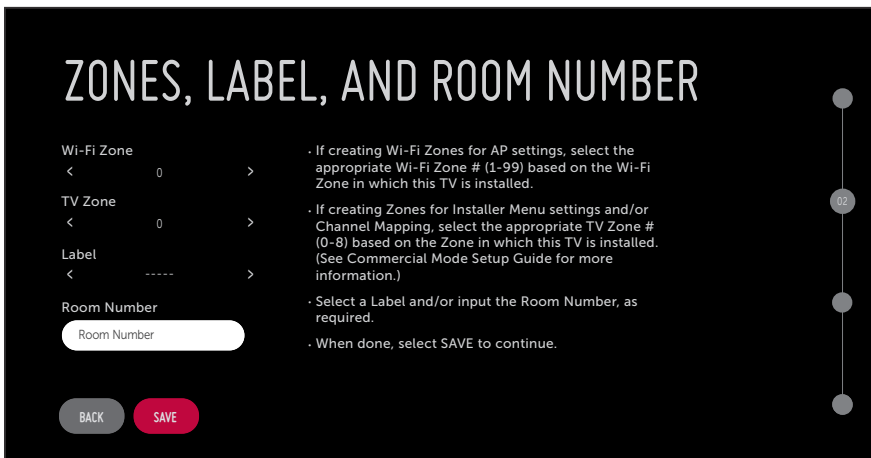

(Continued on next page)

Solution Settings / EZ-Manager Wizard (Cont.)

(Continued from previous page)

Note: Zoning features are only applicable for TVs that will be configured using a “.tlx” file (local or remote configuration).

1. Complete the appropriate field(s) as described below. Use the Up/Down arrow keys on the Installer Remote to navigate between each of the fields.
 - **Wi-Fi Zone:** Enables you to set a Wi-Fi Zone # so that the TV can be configured with a particular access point's login data for wireless networking. Login data (i.e., SSID, security type, and security key) may be provided in a Clone/Configuration (.tlx) file.
To assign a Wi-Fi Zone, navigate to the Wi-Fi Zone field at the top left of the screen, and use the Left/Right arrow keys to specify the desired Wi-Fi Zone # (1–99).
 - **TV Zone:** Enables you to set a TV Zone # so that the TV can be configured with Installer Menu and/or Setup Menu settings intended only for the assigned Zone. The Installer Menu and/or Setup Menu settings may be provided in a Clone/Configuration (.tlx) file. If the TV is being configured for FTG Mode, the TV Zone # setting also allows the TV to omit channels that have been restricted in the FTG Channel Map.
To change the TV Zone from its default value (0), navigate to the TV Zone field, and use the Left/Right arrow keys to specify the desired TV Zone # (1–8).
 - **Label:** Allows you to select a North, South, East, or West text label for this TV. In the Label field, use the Left/Right arrow keys to select the applicable label.
 - **Room Number:** Allows you to specify the number of the room—up to 16 characters—in which the TV is located. To enter a room number, navigate to the Room Number field and press **OK**. You can then use the number keys on the Installer Remote to direct enter a room number, or you can use the arrow keys to select the appropriate alphanumeric character(s) from the pop-up virtual keyboard at the bottom of the screen. When you are done, select **Enter** from the virtual keyboard, and then press **OK** on the Installer Remote.
Note: The TV name (default: TV serial number + model name) will be changed to the room number specified here. See “Media Share Setup” on pages 81 to 83 for further information on the TV name.
2. When you are ready to continue, use the arrow keys to select **SAVE**, and then press **OK** on the Installer Remote to return to the TV Configuration Options screen. Then, proceed as required from the TV Configuration Options screen.

Network Settings

You may configure wired and/or wireless network settings for the TV.

Note: If desired, you can configure both wired and wireless connections to the Local Area Network (LAN). However, note that a wired connection is always prioritized over a wireless connection. That is, if an Ethernet cable is connected between the network and the TV's LAN port, the TV will default to the wired connection. If the Ethernet cable is removed, the TV will then attempt to establish the wireless connection. Whenever the Ethernet cable is reconnected to the TV's LAN port, the TV will re-establish the wired connection.

(Continued on next page)

Solution Settings / EZ-Manager Wizard (Cont.)

(Continued from previous page)

1. Refer to the appropriate subsection(s) below for information on configuring the wired and/or wireless connection(s) between the TV and the network.

Configure a Wired Network Connection

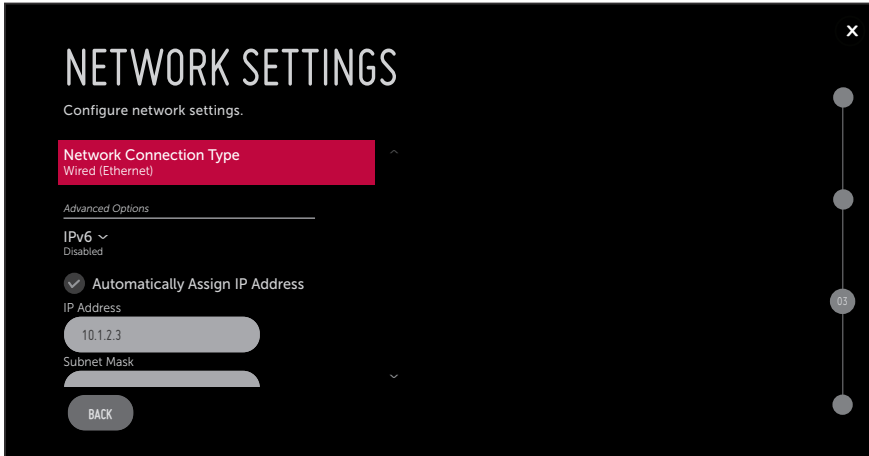

- a. If not already done, connect the appropriate cable between the TV and the network.
- b. Make sure the **Wired (Ethernet)** option is selected in the Network Connection Type field, and then press **OK** on the Installer Remote.
- c. By default, the TV uses DHCP, and if a LAN is detected, the TV will request an IP address from the DHCP server on the network. If the TV is able to connect to the network, the network configuration data will be displayed on the screen as shown in the example above.
If the network is not configured for DHCP, or if you want to enable/disable IPv6 or specify static IP configuration data (applicable only for IPv4), continue with steps (d) and/or (e), respectively.
- d. (Optional) To enable IPv6, select/highlight the IPv6 field and press **OK**. Then, select **Enabled** from the drop-down list of options.
- e. (Optional / IPv4 only) If required, you can edit the IP data for this TV as follows:
 - De-select the "Automatically Assign IP Address" checkbox under "Advanced Options."
 - For each data entry field: Use the arrow keys on the Installer Remote to select the field and press **OK**. You can use the number keys on the Installer Remote to direct enter numeric values or use the arrow keys to select the appropriate characters from the pop-up virtual keyboard displayed at the bottom of the screen. When you are done, select **Enter** from the virtual keyboard, and then press **OK** on the Installer Remote.

Note: You must use the dot "." key from the virtual keyboard to separate each octet of an IP address.

(Continued on next page)

(Continued from previous page)

Configure a Wireless (Wi-Fi) Network Connection

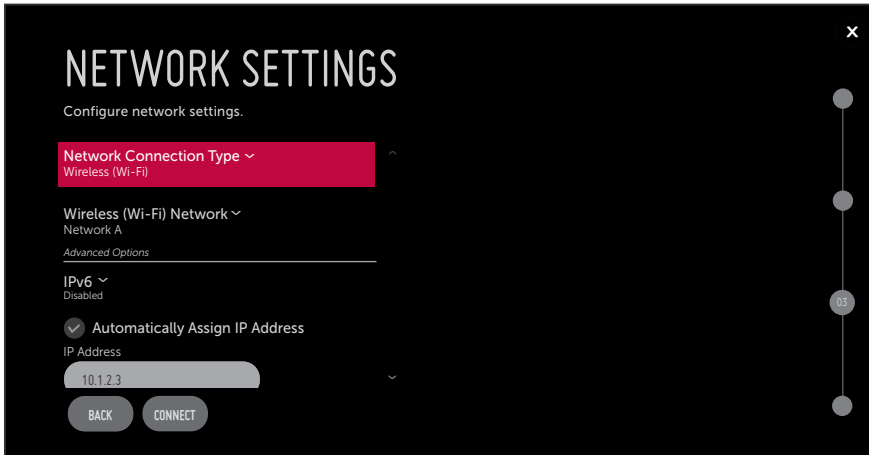

- a. Select/highlight the Network Connection Type field, and press **OK** on the Installer Remote. Then, use the Up/Down arrow keys to select/highlight **Wireless (Wi-Fi)**, and press **OK** once more.
 - b. Select/highlight the Wireless (Wi-Fi) Network field, and press **OK** on the Installer Remote. Then, use the Up/Down arrow keys to select/highlight the desired access point from the drop-down list of available options, or select the “Hidden Network” option at the bottom of the list to specify an access point with a hidden SSID. Press **OK** once more.
Note: Make sure you have the network security password—at least eight, but no more than 32 characters—or PIN available if you are attempting to connect to a secured network. If you would like to add an access point with a hidden SSID, you will need to direct enter the SSID—up to 32 characters—of the access point.
 - c. Follow the on-screen instructions to complete the appropriate network configuration. Use the Installer Remote to navigate between fields and make entries, etc.
Note: As with a wired connection, you will have the option to specify static IPv4 configuration data for this network connection. Once the initial connection is established, you can de-select the “Automatically Assign IP Address” checkbox under “Advanced Options,” and then modify the IP data, as required. See step (e) of the wired connection procedure above for further information on the data entry fields.
 - d. (Optional) To enable IPv6, select/highlight the IPv6 field and press **OK**. Then, select **Enabled** from the drop-down list of options.
 - e. Once the wireless network configuration is complete, Use the arrow keys on the Installer Remote to select **CONNECT**, and then press **OK** on the Installer Remote.
Note: The “CONNECT” button disappears once the connection is successful.
2. When you are ready to continue, use the arrow keys to select **BACK**, and then press **OK** on the Installer Remote to return to the TV Configuration Options screen. Then, proceed as required from the TV Configuration Options screen.

Solution Settings / EZ-Manager Wizard (Cont.)

Configure Pro:Centric Settings

Once you select “NEXT” from the TV Configuration Options screen, the Searching for Pro:Centric Server screen is displayed, and you have the following options:

- You can allow the EZ-Manager Wizard to proceed with a series of automated steps to configure the TV for Pro:Centric operation and then to look for the Pro:Centric application and maintenance (E-Z Installation) files to download. In this case, the wizard uses a search algorithm to determine the Data Channel and the Pro:Centric Application Mode to set in the TV.

Continue with the “Automated Pro:Centric Configuration” subsection below.

- If you already know the settings (e.g., Data Channel and Pro:Centric Application Mode) that need to be configured in order for the TV to connect to the Pro:Centric server and/or if the Pro:Centric server is not yet installed, you may expedite the setup process by entering this data manually.

Continue with the “Manual Pro:Centric Configuration” subsection on page 32.

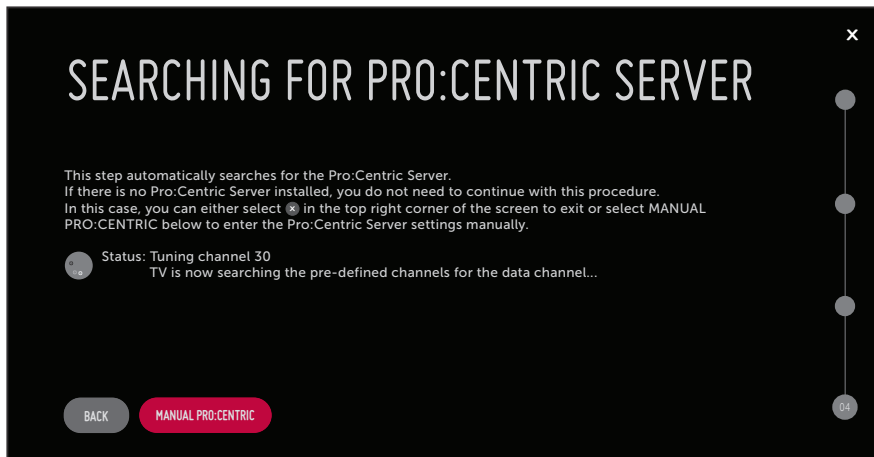

Automated Pro:Centric Configuration

Note: If the server is not yet configured on the system or if Pro:Centric data delivery will be over IP and there is no Domain Name System (DNS) server, use the manual configuration option to configure the TV’s Pro:Centric server settings (see “Manual Pro:Centric Configuration” subsection on page 32). See also note below regarding DNS requirements.

Note: If there is a DNS server at the site, you can create a “procentric.local” DNS entry with the Pro:Centric server’s IP address. Also, the Pro:Centric server’s port number must be set to “80” to allow the automated Pro:Centric IP configuration via the EZ-Manager to find the server.

Once the Pro:Centric data channel is found (a Pro:Centric Server Was Found screen will be displayed) and the Pro:Centric Application Mode is determined, the wizard will advance to the Processing the Pro:Centric Configuration screen, which shows the progress of the data downloads (see example on following page). Note that some steps may require a few minutes.

(Continued on next page)

(Continued from previous page)

If the process is successful, no further user interaction is required, though, in some instances, where the option (for example, "NEXT") is available, you may manually move forward to subsequent steps within the wizard to speed up the process.

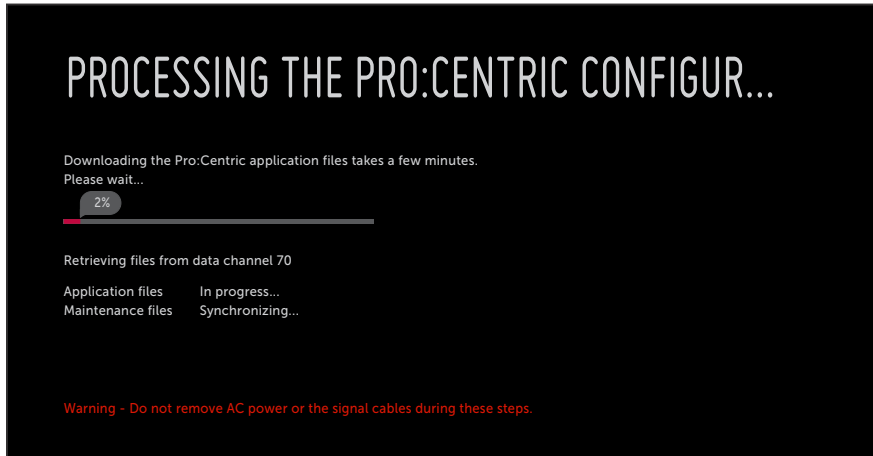

Note: If, after completing the search, the TV is unable to find the Pro:Centric data channel (while the Searching for Pro:Centric Server screen is on display), the wizard will stop and show a Diagnostics screen that enables you to manually return to the previous screen (to reinitiate the configuration) or exit the wizard.

When the Pro:Centric Configuration is complete, an EZ-Manager Configuration Complete screen is displayed (see example below), and after 10 seconds, the wizard exits, and the TV turns OFF.

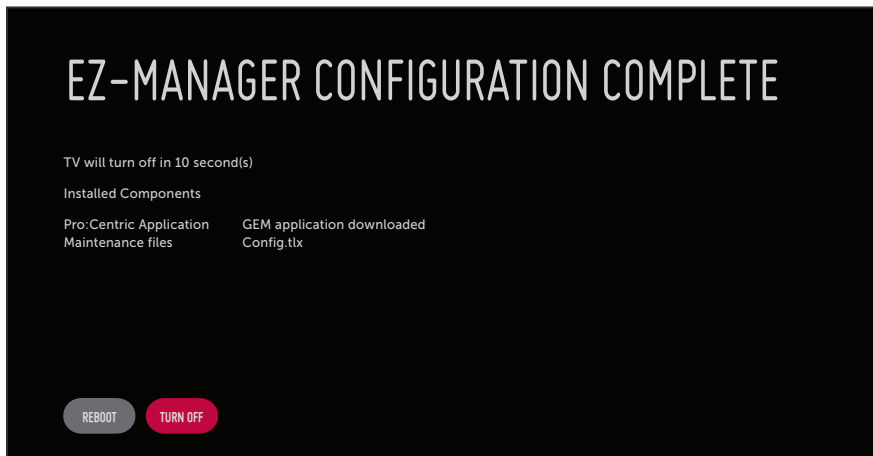

Note: With the EZ-Manager Configuration Complete screen on display, you can also manually turn off or reboot the TV. If desired, select **TURN OFF** or **REBOOT**, respectively, and then press **OK** on the Installer Remote.

(Continued on next page)

Solution Settings / EZ-Manager Wizard (Cont.)

(Continued from previous page)

Manual Pro:Centric Configuration

1. With the Searching for Pro:Centric Server screen on display, use the Left/Right arrow keys on the Installer Remote to select **MANUAL PRO:CENTRIC** at the bottom of the screen, and then press **OK**.

In the Pro:Centric Manual Configuration screen (see examples below), you will be able to configure the appropriate Pro:Centric settings in the TV. Use the Up/Down arrow keys on the Installer Remote to navigate between fields.

2. In the Pro:Centric Mode field, use the Left/Right arrow keys to select the appropriate Pro:Centric Application Mode—**GEM** (Java), **HTML**, or **CONFIGURATION ONLY**.

Note: For remote management only, select **CONFIGURATION ONLY**. The TV will search for TV E-Z Installation data downloads; however, Pro:Centric application data will not be downloaded, i.e., Installer Menu item 098 PRO:CENTRIC will be set to 0.

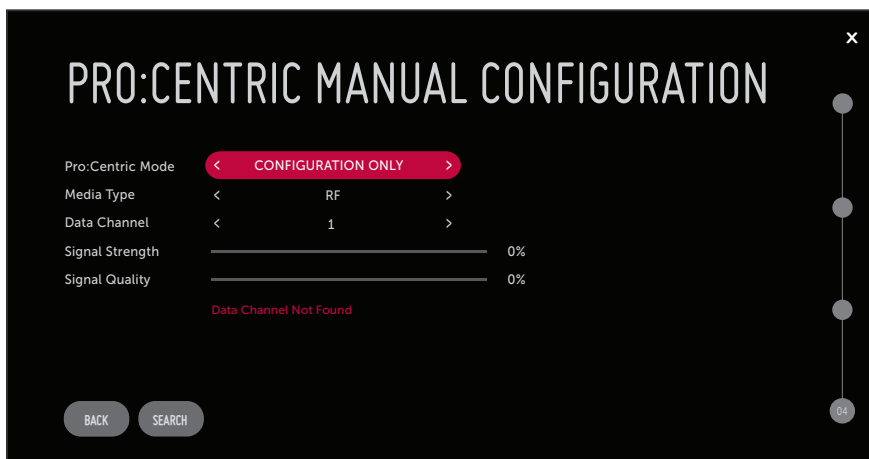

Pro:Centric Manual Configuration Screen with RF Media Fields

Note: By default, the Pro:Centric Manual Configuration screen initially shows RF configuration fields.

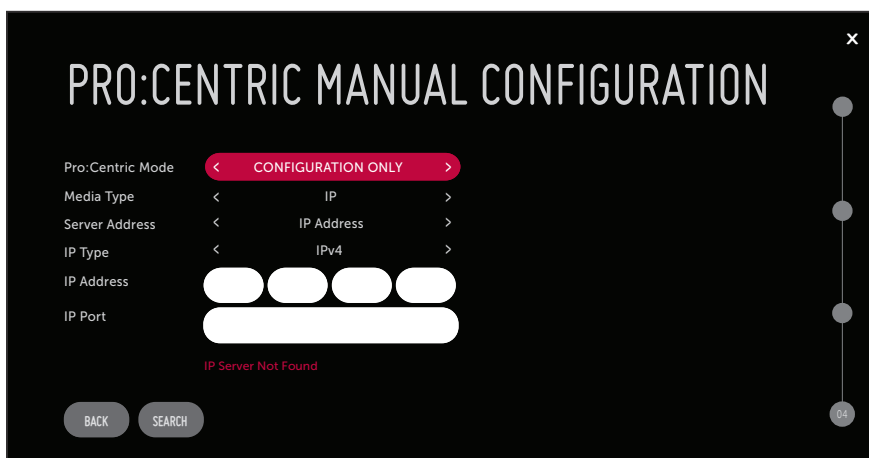

Pro:Centric Manual Configuration Screen with IP Media Fields

(Continued on next page)

(Continued from previous page)

3. Refer to the appropriate subsection below, depending on the Pro:Centric server configuration, to complete the remaining fields.

RF Configuration

- a) In the Media Type field, use the Left/Right arrow keys to select **RF**.
- b) In the Data Channel field, use the Left/Right arrow keys to select the RF channel number that will be used by the Pro:Centric server as its data channel. The Data Channel value can be set from 1 to 135.*

IP Configuration

- a) In the Media Type field, use the Left/Right arrow keys to select **IP**.
Note: When you select "IP" as the Media Type, the default RF Data Channel and Signal Strength/Quality fields are replaced with Server Address, IP Type, IP Address, and IP Port fields.
- b) The Server Address field provides the option to specify the domain name of the Pro:Centric server instead of the server's IP address. Use the Left/Right arrow keys to select the desired option—IP Address or Domain Name—for defining the server.
- c) Depending on your selection in the previous step, either:
 - Select the appropriate IP type (either IPv4 or IPv6) in the IP Type field, and then enter the Pro:Centric server IP address in the IP Address field. The IP address must match the IPv4 or IPv6 (as applicable) address that is set in the Pro:Centric server.
 - Enter the Pro:Centric server domain name—up to 63 characters (no spaces allowed)—in the Domain Name field. Note that in order for the domain name to be resolved to an IP address, there must be a DNS entry for the domain name.

For each data entry field: Use the arrow keys to select the field and press **OK**. Then, you can either use the number keys on the Installer Remote to directly enter data values, or you can use the arrow keys to select the appropriate number(s)/alphanumeric character(s) from the pop-up virtual keyboard displayed at the bottom of the screen. When you are done, select **Enter** from the virtual keyboard, and then press **OK** on the Installer Remote.

Note: For an IPv6 IP address, you must use the colon ":" key from the virtual keyboard to separate each group.

- d) Enter the Pro:Centric server port number in the IP Port field. The port number must match the port number that is set in the Pro:Centric server.
4. Once all fields are completed as required, you have two options:
 - To save the data entered and exit the wizard, use the arrow keys to select the **✕** button at the top right of the screen, and then press **OK**. In the subsequent pop-up confirmation window, select **SAVE & EXIT**, and then press **OK** once more. The Pro:Centric application and/or E-Z Installation data will be downloaded to the TV at a later time. This option is useful, in particular, if the Pro:Centric server has not yet been configured.

(Continued on next page)

* PCS150R and later Pro:Centric servers do not support HRC or IRC cable channel frequencies.

Solution Settings / EZ-Manager Wizard (Cont.)

(Continued from previous page)

- To initiate a real-time download of Pro:Centric application and/or E-Z Installation data, use the arrow keys to select **SEARCH** and press **OK** to verify the configuration data provided in step 3. When the data is verified, the “SEARCH” button becomes a “NEXT” button. Select **NEXT** and press **OK** to continue (see also note below).

Note: With RF configuration, Pro:Centric server data must be present on the RF channel selected as the TV’s Data Channel in order for you to select “NEXT” (you will see a “Data Channel Found” message below the Signal Quality indicator). With IP configuration, Pro:Centric server data must be present via the wired LAN cable connection in order for you to select “NEXT” (you will see a “IP Server Found” message below the IP Port field).

If you opt to initiate a real-time download in the last step, the EZ-Manager Wizard will proceed with the Pro:Centric application and/or E-Z Installation data downloads (see Processing the Pro:Centric Configuration screen example on page 31). When the Pro:Centric configuration is complete, an EZ-Manager Configuration Complete screen (see example on page 31) is displayed, and after 10 seconds, the wizard exits, and the TV turns OFF.

Note: With the EZ-Manager Configuration Complete screen on display, you can also manually turn off or reboot the TV. If desired, select **TURN OFF** or **REBOOT**, respectively, and then press **OK** on the Installer Remote.

USB Configuration

TV Manager / USB download options enable you to download configuration, image, or software files from a USB memory device to the TV. You can also use the Ez Download utility available from the menu to select multiple types of files to be downloaded at one time using one process.

Each of the USB download functions requires that you have the appropriate file(s) loaded on a USB memory device. If you wish to perform a software update or download image/icon/video files, the applicable file(s) must be stored in a folder named “LG_DTV” in the root directory of the USB memory device. Clone/Configuration (.tlx) files should simply be stored in the root directory of the USB device.

Note: If appropriate, you may download a Pro:Idiom Media Key (.pim) file via the Ez Download utility. The “.pim” file must be stored in a folder named “LG_DTV” in the root directory of the USB memory device. See Reference section, “Downloading a Pro:Idiom Media Key using a USB Memory Device,” for further information on file requirements.

The procedure below assumes the desired file(s) is/are already loaded onto the USB device. For further information on the TV Manager / USB download options and file requirements, and/or for information on creating Clone/Configuration (.tlx) files, refer to the appropriate section(s) in this document.

Before You Begin

- If you intend to use the Zoning feature(s) on this TV, make sure to set the appropriate TV Zone # and/or Wi-Fi Zone # in the EZ-Manager’s Zones, Label, and Room Number screen BEFORE continuing with USB Configuration. See “TV Configuration Options” on page 25 for further information.

(Continued on next page)

(Continued from previous page)

- Ensure the USB device to be used has been formatted with FAT format.
- When creating files to be downloaded, avoid using special characters (?, &, @, etc.) in filenames.
- Refer to “Ez Download Utility” on pages 37 to 41 for further information on the Ez Download utility.
- Refer to “Custom Master TV Setup” on pages 54 to 56 for information on creating a Clone (.tlx) file, and/or refer to “Creating an FTG Configuration File” on pages 64 to 66 for information on creating an FTG Configuration (.tlx) file for FTG Mode configuration.
- See Reference section, “Downloading Images or Icons using a USB Memory Device,” for image and icon guidelines.
- See Reference section, “Downloading a Hotel Video using a USB Memory Device,” for video guidelines.
- See Reference section, “Updating TV/PTC Software using a USB Memory Device,” for further information on software updates.

USB Configuration via EZ-Manager Wizard

With either the TV Configuration Options or the Zones, Label, and Room Number screen on display, proceed as follows to configure the TV using the USB memory device.

1. Insert the USB memory device with the appropriate file(s) into either of the TV’s USB ports.
2. Use the arrow keys on the Installer Remote to select **USB CONFIGURATION**, and then press **OK**.

You will be redirected to the TV Manager / USB download options.

Note: You can select the **✕** button at the top right corner of the screen and press **OK** on the Installer Remote at any time to return to the EZ-Manager Wizard.

Note: Ez Download is always selected by default when you initially access the TV Manager. Also note that Diagnostics is for service use only.

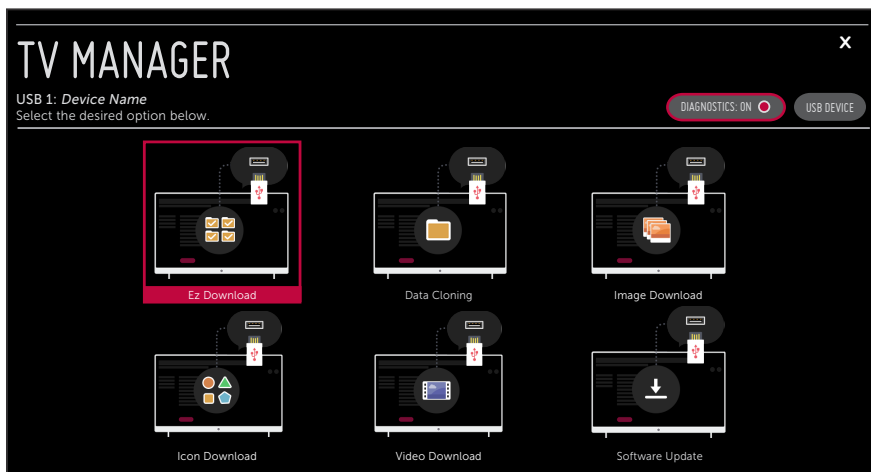

(Continued on next page)

Solution Settings / EZ-Manager Wizard (Cont.)

(Continued from previous page)

3. If more than one USB memory device is currently connected to the TV, be sure to select the USB device that contains the file(s) you wish to use. If necessary, use the arrow keys on the Installer Remote to select/highlight the **USB DEVICE** button at the top right of the screen and press **OK**. Then, use the Up/Down arrow keys to select the appropriate USB device from the pop-up list of USB devices displayed at the top of the screen.

4. Select the appropriate option from the TV Manager, and initiate the desired download(s)/update(s).

Download/update progress will be displayed on the screen. Do NOT remove the USB device while downloads/updates are in progress. When the process is complete, the TV will reboot. Upon restart, depending on the type of download(s)/update(s) completed, either the EZ-Manager TV Configuration Options screen will be redisplayed (image, video, and/or software downloads/updates only) or the TV will tune according to the Start Channel setting in the Installer Menu (TV configured with Clone/Configuration file).

Note: If the TV Configuration Options screen is redisplayed (image, video, and/or software downloads/updates only), you can either proceed with configuration via the EZ-Manager Wizard or exit the EZ-Manager Wizard, as required.

5. Remove the USB memory device, and verify that the appropriate configuration/download(s)/update(s) is/are resident on the TV.

The Ez Download utility, available from the TV Manager, enables you to select multiple files at one time from the files loaded on a USB memory device. You may use this utility to download any one or all of the following to a TV:

- One Clone or FTG Configuration (.tlx) file
- One TV CPU software update
- One PTC software update
- One Pro:Idiom Media Key (.pim) file
- One boot logo image
- Up to 12 (or 10 MB) application background images
- Up to 12 (or 10 MB) images for each hotel directory in a customized portal
- One hotel icon for a customized portal
- One icon for each website shortcut in a customized portal
- One hotel video for a customized portal

Before You Begin

- Ensure the USB device has been formatted with FAT format.
- Software update, image/icon, video, and Pro:Idiom Media Key files must be stored in a folder named "LG_DTV" in the root directory of the USB memory device. Clone/Configuration (.tlx) files should simply be stored in the root directory of the USB device.
- If you have initiated the Solution Settings / EZ-Manager Wizard, you can use the wizard's "USB Configuration" option to access the Ez Download utility, if desired (see "TV Configuration Options" and/or "USB Configuration" on pages 25 and 34, respectively, as necessary).
- If the TV is currently in Pass-through Mode and you intend to use the Zoning feature(s) on this TV for location-specific configuration purposes, make sure to set the appropriate TV Zone # and/or Wi-Fi Zone # in the TV when directed to do so in the procedure below.
- When creating files to be downloaded, avoid using special characters (?, &, @, etc.) in filenames.
- Refer to "Custom Master TV Setup" on pages 54 to 56 for information on creating a Clone (.tlx) file, and/or refer to "Creating an FTG Configuration File" on pages 64 to 66 for information on creating an FTG Configuration (.tlx) file for FTG Mode configuration.
- See Reference section, "Downloading Images or Icons using a USB Memory Device," for image and icon guidelines.
- See Reference section, "Downloading a Hotel Video using a USB Memory Device," for video guidelines.
- See Reference section, "Updating TV/PTC Software using a USB Memory Device," for further information on software updates.
- See Reference section, "Downloading a Pro:Idiom Media Key using a USB Memory Device," for further information on file requirements.



Caution: Do not unplug the TV power cord or remove the USB memory device during a data download, as doing so may cause the TV to malfunction or harm the USB device, respectively.

Ez Download Utility (Cont.)

Accessing and Using the Ez Download Utility

1. If it is not ON already, turn ON the TV.
2. The next step depends on whether the First Use Wizard appears on the screen when you turn ON the TV:
 - If the wizard is displayed, you can access the Ez Download utility via the Solution Settings / EZ-Manager Wizard, as indicated above (see “Before You Begin”). However, to continue with this procedure and access the Ez Download utility from the TV menus, exit the First Use Wizard. Then, continue with step 3.
 - If the wizard is not displayed, go directly to step 3.
3. If the TV is currently in Pass-through Mode, you would like to transfer (import) a “.tlx” file to the TV via the Ez Download utility, and you intend to use one or both of the TV’s Zoning feature(s), set the appropriate TV Zone # and/or Wi-Fi Zone # in the TV at this time. See Reference section, “Using the TV’s Zoning Features,” for further information.



Note: In order for the proper TV Zone and/or Wi-Fi Zone profile data to be applied, the appropriate TV Zone # and/or Wi-Fi Zone # must be set in the Target TV BEFORE you continue with the Ez Download utility.

4. Insert the USB memory device with the appropriate file(s) into either of the TV’s USB ports.
5. To access the TV Manager from the TV menus:
 - Press **MENU SETTINGS** on the Installer Remote to display the TV setup menus (TV is in Pass-through Mode) or the Function Menu (TV is not in Pass-through Mode).
 - If the Quick Settings Menu is displayed at the left of the screen (i.e., the TV is in Pass-through Mode), select the **All Settings**  menu icon and press **OK** to access the advanced TV setup menus.
 - Use the arrow navigation keys to select/highlight either the **General** menu icon from the TV setup menus or the **Safety** menu icon from the Function Menu. Then, press the number “7” key a total of seven times.

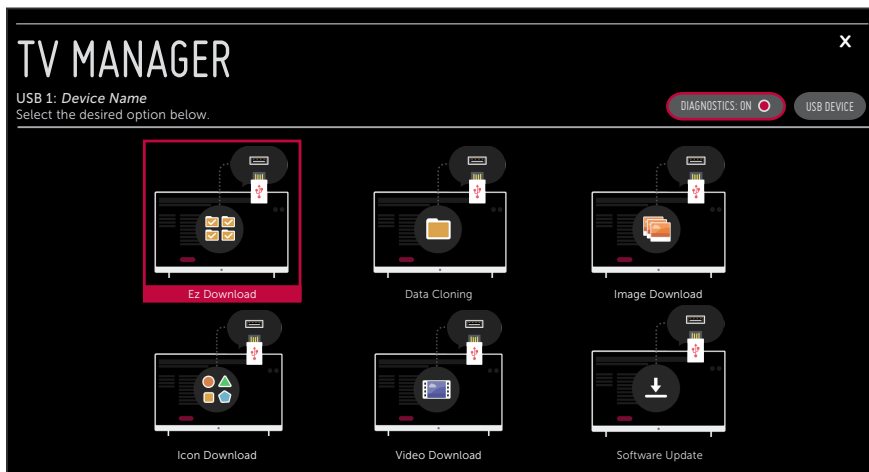

(Continued on next page)

(Continued from previous page)

Note: Ez Download is always selected by default when you initially access the TV Manager. Also note that Diagnostics is for service use only.

6. If more than one USB memory device is currently connected to the TV, be sure to select the USB device that contains the file(s) you wish to use. If necessary, use the arrow keys on the Installer Remote to select/highlight the **USB DEVICE** button at the top right of the screen and press **OK**. Then, use the Up/Down arrow keys to select the appropriate USB device from the pop-up list of USB devices.

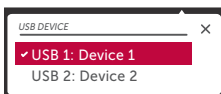

7. If it is not currently selected, use the arrow keys to select **Ez Download**, and then press **OK**.

In the Ez Download screen, a list of files/file types is displayed on the left. Remember that image/icon/video, Pro:Idiom Media Key, TV software (CPU), and PTC software files must be stored in the LG_DTV folder and Clone/Configuration (.tlx) files must be stored in the root directory on the USB device.

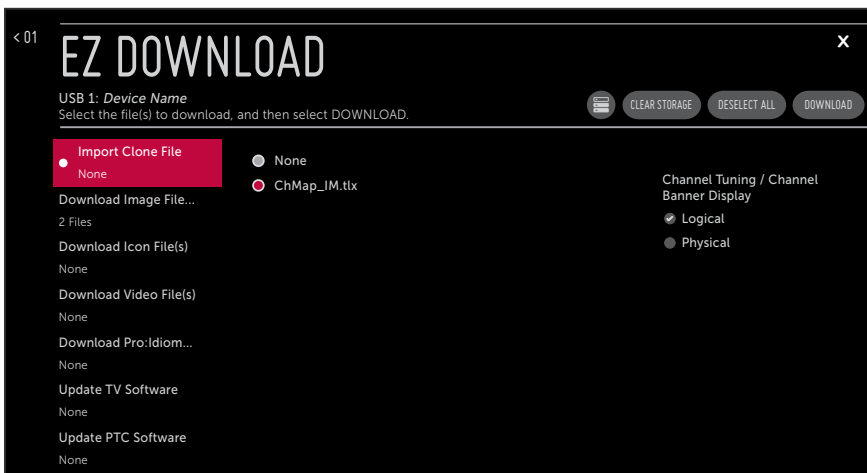

Note: Select the **X** button in the top right corner of the screen, as necessary, to exit the TV Manager. If you accessed the TV Manager via the Solution Settings / EZ-Manager Wizard, you will be returned to the last screen on display before you selected the “USB Configuration” option. If you accessed the TV Manager via the TV menus, you will be returned to program viewing. You can also return/navigate to the TV Manager main screen by selecting **< 01** in the top left corner of the Ez Download screen.

Note: The “Download Pro:Idiom M Key” option only appears if a “.pim” file is detected on the USB device.

(Continued on next page)

Ez Download Utility (Cont.)

(Continued from previous page)

8. To select a file:

- Use the arrow keys on the Installer Remote to select/highlight the appropriate file type field, and then press **OK**.

A list of available files is displayed to the right of the file type fields. In the case of image/icon/video files, once you select the initial “Download Image File(s)” or “Download Icon File(s)” or “Download Video File(s)” option, you will need to also select the appropriate type of image/icon/video file (boot logo image, background image, etc.) before selecting the image/icon/video file(s) itself/themselves.

- Then, use the arrow keys to select the desired file(s).

Note: With the exception of background and hotel directory image files, the utility will only allow you to select one of each file type for downloading. For example, if there are two files in the Ez Download “Import Clone File” list, you can only select one or the other of those two files.

Note: The initial default value for each file type is “None.” After the Ez Download utility is run, a file is automatically created and stored on the USB device that was used. The file, which will have a “.dzm” file extension, maintains a history of the file(s) previously used with the Ez Download utility. The next time(s) you use this USB device with the Ez Download utility, the file(s) selected for the last download will be pre-selected for the current download, thus facilitating the process of configuring additional TVs of this model using the same USB device. If you ever want to restore the file selections on the Ez Download screen to “None,” select the **DESELECT ALL** button and press **OK**.

Note: The current TV software (CPU) or PTC software version is always displayed above the listing of available TV software and PTC software files, respectively. Ensure the software version of the selected file is the correct version before applying the update to this TV.

Note: You can select the  (STORAGE) button at the top of the Ez Download screen to check the amount of storage available for and currently in use by media (image, icon, and video) files. Storage data will be displayed in a pop-up window. When you are finished, select **OK** to close the pop-up window. If you would like to clear all of the media files currently in storage, select the **CLEAR STORAGE** button. Then, in the confirmation pop-up window, select **YES** to clear all of the media files, or select **NO** to return to the Ez Download screen without clearing the media files.

9. If a Clone/Configuration (.ttx) file that includes an FTG Channel Map is selected, a Channel Tuning / Channel Banner Display field will be displayed at the right of the screen. If the FTG Channel Map comprises RF channels and Aux inputs *only* (the latter designated by 130-0 through 137-0), you can choose the format for the channel tuning/banner display. Use the arrow keys on the Installer Remote to select **Logical** tuning or **Physical** tuning. A checkmark will appear at the left of the selected option. Logical tuning is selected by default.

Note: If an FTG Channel Map includes IP channels, only logical tuning is available. Also, if the selected “.ttx” file does not include an FTG Channel Map, the message, “No Channel Map in Clone file,” will be displayed at the right of the screen.

(Continued on next page)

(Continued from previous page)

10. When you are ready to continue, use the arrow keys on the Installer Remote to select **DOWNLOAD**, and then press **OK**.

Download/update progress will be displayed on the screen. Do NOT remove the USB device while downloads/updates are in progress. When the Ez Download process is complete, an overview of the results will briefly be displayed and then, the TV will reboot.

11. Remove the USB memory device, and verify that the appropriate configuration/download(s)/update(s) is/are resident on the TV.

Note: If you updated the TV configuration with a Clone/Configuration file, upon restart, the TV tunes according to the Start Channel setting in the Installer Menu. If a Start Channel is specified, the TV will tune to that channel, though in the case of FTG Mode configuration, a channel banner will only be displayed if the Start Channel is included in the FTG Channel Map (depending on your selection in step 9, the channel banner will display either the Start Channel's logical channel number or physical RF channel number). Otherwise, the TV will either return to the last channel tuned (TV in Pass-through Mode) or tune to the first channel in the FTG Channel Map (TV in FTG Mode). In the latter case, remember that the channels in the FTG Channel Map are always arranged in logical order, regardless of your selection in step 9.

Installer Menu

Use the Installer Menu to set up, change, or view operational settings. This section describes how to access, use, and exit the Installer Menu from the TV itself. However, you should also refer to the Installer Menu descriptions in this document if you are configuring the TV CPU using an FTG Configuration (.tlx) file created using LG's Cloud Configuration Tool.

Refer to the table on pages 44 to 45 for brief descriptions of Installer Menu items. More detailed descriptions follow the table listing.

Accessing the Installer Menu

1. Turn ON the TV.

If the First Use Wizard appears on the screen when you turn ON the TV, exit the wizard.

2. Using an Installer Remote, press **MENU SETTINGS** repeatedly until the on-screen display of the TV setup menus (if the TV is in Pass-through Mode) or the Function Menu (if the TV is not in Pass-through Mode) no longer toggles, and then press the Installer Menu entry sequence (e.g., **9-8-7-6**) + **OK** to access the Installer Menu.

Note: The default Installer Menu entry sequence is "9876"; however, if Installer Menu item 000 INSTALLER SEQUENCE has been modified, the entry sequence may be one of three additional options. See Installer Menu detailed descriptions for further information.

The Installer Menu opens with item 000 INSTALLER SEQ 000.

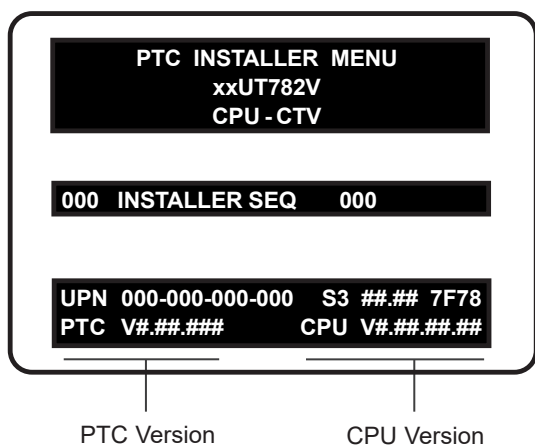

Typical Installer Menu

The Installer Menu header will vary depending on the TV you are setting up. In the Installer Menu footer, you can see the current software versions of the TV, as indicated.

Note: If the password (entry sequence) is not entered or registered correctly, you will see the message "ENTER PASSWORD 0000" at the top of the screen instead of the Installer Menu header. Once you re-enter the correct password (e.g., press 9-8-7-6 + OK), the Installer Menu will display.

Note: If the TV is not in Pass-through Mode, the Installer Menu is accessible as read-only. Also, the TV Zone # will be indicated in the Installer Menu header under the configuration mode indicator described below.

As part of the Installer Menu header (in all modes), two 3-character acronyms are displayed to indicate the TV's current configuration mode. The table below lists all possible mode identifiers for these TV models.

| Acronym | Description |
|---------|---|
| CPU-CTV | (Default) Pass-through Mode with or without Channel Lineup in CPU |
| CPU-FTG | FTG Mode via CPU |
| CPU-P:C | Application Tuning Mode via CPU |
| MPI-EXT | External MPI Control |
| PTC-CTV | Pass-through Mode with Channel Map in PTC |

Navigating Within the Installer Menu

Use the Up/Down arrow keys on the Installer Remote to sequence through the available menu items, or access an item directly by keying in the item number and then pressing **MENU SETTINGS**. For example, to access the SLEEP TIMER option, which is item 015, press 0-1-5 + MENU SETTINGS.

Installer Menu items not relevant to these TV models are not present in the Installer Menu; therefore, some numbers are missing. For example, item 006 will not appear. In addition, items that are dependent on other Installer Menu item settings will not be initially accessible. For example, item 046 STRT AUX SRCE will not display in the Installer Menu unless item 004 STRT CHANNEL is set to 0. See Installer Menu detailed descriptions for further information.

Modifying Installer Menu Settings

Refer to the table starting on the next page for an overview of the available Installer Menu items, including their item numbers, functions, value ranges, and default values.

To change an Installer Menu item value, use the Left/Right arrow keys on the Installer Remote to select the appropriate value, or direct enter a valid value. To save the new setting, press **OK** once on the Installer Remote. If you have additional items to modify, use the Up/Down arrow keys to navigate to a new Installer Menu item or access an item directly as described in the previous section. Note that invalid values will not be saved.

 **Caution:** In order for Installer Menu item changes to be saved, you must press **OK** as indicated above and then exit the Installer Menu as described below. Never remove power from the TV while in the Installer Menu. Also, remember that Installer Menu settings may affect options available from the TV setup menus or the Function Menu.

Exiting the Installer Menu and Activating Settings

After you have saved all desired Installer Menu item changes (i.e., press **OK** once on the Installer Remote to save changes), press **OK** again to exit the Installer Menu. Any changes you make will be stored in non-volatile memory.

Note: Each time you exit the Installer Menu in Pass-through Mode, all V-Chip (Parental Control) settings in the TV are reset to their default values; that is, the Lock System, if previously enabled from the Safety Menu, will now be disabled, and the individual Parental Control settings will be restored to default values.

Installer Menu (Cont.)

Installer Menu Items 000 through 053

| Item | Function | Value Range | Default Value | Brief Description of Function |
|------|----------------|-----------------|---------------|---|
| 000 | INSTALLER SEQ | 0–3 | 0 | Leave default set to 0. |
| 001 | POWER MANAGE | 0–15* | 0 | Selects the number of hours of inactivity allowed before the TV automatically turns itself OFF and also determines the availability of the Force TV Reboot with IR Remote feature. See detailed descriptions. |
| 002 | AC ON | 0–3, 16–19 | 0 | Determines the status of the TV (ON, Instant ON enabled, etc.) when AC power is applied. See detailed descriptions. |
| 003 | BAND/AFC | 0–3 | 1 | Selects the RF Tuning Band: 0=Broadcast, 1=Cable, 2=HRC, 3=IRC |
| 004 | STRT CHANNEL | 0–127, 253, 255 | 255 | Channel tuned when the TV is turned ON. (Set to 255 to tune to channel tuned before the TV was turned OFF.) |
| 005 | CHAN LOCK | 0 / 1 | 0 | If set to 1, cannot tune from current channel. |
| 007 | STRT VOLUME | 0–63, 255 | 255 | Volume level when the TV is turned ON. (Set to 255 to use volume level set before the TV was turned OFF.) |
| 008 | MIN VOLUME | 0–63 | 0 | Sets the minimum allowable volume setting. |
| 009 | MAX VOLUME | 0–63 | 63 | Sets the maximum allowable volume setting. |
| 010 | MUTE DISABLE | 0 / 1 | 0 | Set to 1 to disable the Mute function. |
| 015 | SLEEP TIMER | 0 / 1 | 1 | Set to 1 to enable the Sleep Timer feature. |
| 016 | EN TIMER | 0 / 1 | 0 | Set to 1 to enable On/Off timers. |
| 017 | ALARM | 0 / 1 | 1 | Set to 1 to enable the Alarm feature in the Function Menu. |
| 020 | FEATURE LEVEL | 0, 16–24 | 0 | Determines an additional IR code scheme to which the TV will respond. |
| 021 | V-CHIP | 0 / 1 | 1 | Set to 1 to enable V-Chip (Parental Control) functions. |
| 022 | MAX BLK HRS | 0–99 | 12 | Determines the number of Parental Control blocking hours that can be set in the Function Menu. |
| 023 | CAPTION LOCK | 0 / 1 | 0 | Set to 1 to retain the caption setting selected before the TV was turned OFF. |
| 028 | CH. OVERRIDE | 0 / 1 | 1 | If set to 0, users can only tune to channels that are included in the PTC Channel Map. See detailed descriptions. |
| 029 | REMAP AUX INPS | 0 / 1 | 0 | Set to 1 to remap the PTC's direct tune channels for Aux inputs from 13x to 9x. |
| 030 | EXTCTL/ACKMASK | 0–5** | 0 | Enables/disables the ACK Mask feature of MPI and depending on mode, allows external control. See detailed descriptions. |
| 031 | POLL RATE | 20–169 | 94 | Selects the poll rate for MPI. |
| 032 | TIMING PULSE | 186–227 | 207 | Sets the baud rate for MPI. |
| 035 | HDMI1 ENABLE | 0–2 | 1 | Set to 0 to disable HDMI 1. Set to 1 (DTV Mode) or 2 (PC Mode), as applicable, to enable HDMI 1. |
| 039 | REAR AUX EN. | 0 / 1 | 1 | Set to 1 to enable the display panel AV input jack. |
| 041 | SIMPLINK EN | 0 / 1 | 0 | Determines the status of the SIMPLINK feature. See detailed descriptions. |
| 042 | AUTO INPUTS | 0–255 | 0 | Determines the Aux inputs for which auto-sensing is enabled. See detailed descriptions. |
| 046 | STRT AUX SRCE | 1, 3, 5, 255 | 255 | Sets the starting Aux source (if item 004 STRT CHANNEL is set to 0). |
| 047 | AUX STATUS | 0 / 1 | 0 | Controls the MPI status channel response for Aux sources. Set to 1 for the Aux source to be reported as its channel number. |
| 049 | DIS. AUDIO M. | 0–11 | 0 | Determines the availability of the Sound Out (Audio) Menu in the TV menus, as well as the default Audio Mode when the TV is turned ON. See detailed descriptions. |
| 053 | DIS. CH-TIME | 0 / 1 | 0 | Set to 1 to disable display of the TV's native Channel-Time banner. |

* Values 8 to 15 applicable with PTC v1.00.013 (UT782V0UA and UT782V2UA models)/v1.00.008 (UT782V9UA models) or later.

** Values 2 to 5 (Ext Ctrl) applicable with CPU v3.11.40 or later and PTC v1.00.011 (UT782V0UA and UT782V2UA models)/v1.00.006 (UT782V9UA models) or later.

Installer Menu (Cont.)

Installer Menu Items 069 through 122

| Item | Function | Value Range | Default Value | Brief Description of Function |
|------|-----------------|-----------------|---------------|--|
| 069 | EN. CH-T COL. | 0 / 1 | 1 | Set to 1 to enable custom color for MPI display characters. |
| 070 | FOR. CH-TIME | 0–7 | 2 | Chooses custom foreground color for MPI display characters. |
| 071 | BCK. CH-TIME | 0–7 | 2 | Chooses custom background color for MPI display characters. |
| 073 | CH NOT AVBLE | 0 / 1 | 0 | If set to 1 and item 028 CH. OVERRIDE is set to 0, a "CHANNEL NOT AVAILABLE" message is displayed if the user attempts to direct tune a channel that is not included in the channel lineup. |
| 075 | REVERT CH | 0 / 1 | 0 | If set to 1 and loss of MPI communication occurs, the TV tunes to the Start Channel. |
| 078 | UPN MSB | 0–255 | 0 | User programmable number, most significant byte. |
| 079 | UPN MSB-1 | 0–255 | 0 | User programmable number, most significant byte - 1. |
| 080 | UPN MSB-2 | 0–255 | 0 | User programmable number, most significant byte - 2. |
| 081 | UPN LSB | 0–255 | 0 | User programmable number, least significant byte. |
| 082 | CHKSUM ERROR | 0 / 1 | 1 | Enforces rigid MPI checksum. |
| 083 | HANDSHK TIME | 0–5 | 5 | Determines the MPI timing requirement of an MPI command to follow an MPI Status Response. |
| 084 | PERMANENT BLK | 0 / 1 | 0 | Set to 1 to remove the blocking hours setting in the Function Menu for Parental Control and make the block permanent. |
| 088 | EN NOISE MUTE | 0 / 1 | 1 | (Analog channels only) If set to 1, audio is muted if no signal is present. |
| 090 | KEY LOCK | 0 / 1 | 0 | If set to 1, the display panel power button function is locked. IR is still functional. |
| 091 | HDMI2 ENABLE | 0–2 | 1 | Set to 0 to disable HDMI 2. Set to 1 (DTV Mode) or 2 (PC Mode), as applicable, to enable HDMI 2. |
| 094 | SAP MENU EN | 0 / 1 | 1 | Set to 1 to enable the SAP feature in the Function Menu. |
| 096 | DEF. ASP. RATIO | 0–4 | 2 | Selects the default aspect ratio. See detailed descriptions. |
| 097 | AUDIO OUTPUT | 0–9* | 7 | Set as required in accordance with external audio equipment connected to the TV. See detailed descriptions. |
| | | 0, 9, 10** | 9 | |
| 098 | PRO:CENTRIC | 0, 2, 3 | 0 | Set to 0 to disable the Pro:Centric application. Set to 2 for GEM (Java Application) Mode. Set to 3 for HTML Mode. |
| 099 | BACK LIGHTING | 1–202, 255 | 255 | Sets the level of the TV picture back lighting. See detailed descriptions. |
| 101 | IR FEEDBACK | 0 / 2 | 0 | Set to 2 to disable the TV's MMR feature. |
| 102 | ATSC BAND | 0–4 | 4 | Selects the RF band used by the ATSC tuner. See detailed descriptions. |
| 103 | ATSC TUNE MODE | 0 / 1 | 1 | Set to 1 for Physical Channel tuning. Set to 0 for Virtual Channel tuning. |
| 104 | START MINOR CH | 0–255 | 0 | Selects the Minor Start Channel number. Set to 0 for analog (NTSC) channel. |
| 106 | ASP RATIO LOCK | 0 / 1 | 0 | Set to 0 to use the default aspect ratio each time the TV is turned ON. Set to 1 to retain the aspect ratio set before the TV was turned OFF. |
| 107 | BANNER SELECT | 0 / 1 | 1 | Selects the type of native Channel-Time banner to display during channel change. |
| 116 | VIDEO MUTE EN | 0 / 1 | 0 | (Analog channels only) If set to 1, video mutes (blank screen) when no signal is present. |
| 117 | FACT DEFAULT | 0 / 1 | 0 | Set to 1 to restore the factory default settings of all Installer Menu items. |
| 119 | DATA CHANNEL | 0–135, 253, 255 | 255 | Set to 0 to disable. Set from 1 to 135 to match the RF channel number used by the Pro:Centric server as its data channel. Set to 255 to use Auto Search to find the Pro:Centric RF channel. See detailed descriptions. |
| 121 | UPDATE TIME HR | 0–23, 128, 255 | 128 | Sets the Wake For Update hour. See detailed descriptions. |
| 122 | UPDATE TIME MN | 0–59, 255 | 0 | Sets the minute for Wake For Update. See detailed descriptions. |

* UT782V0UA and UT782V2UA models support values 0–9. ** UT782V9UA models support values 0, 9, 10.

Installer Menu (Cont.)

Detailed Descriptions of Installer Menu Items

000 - INSTALLER SEQUENCE

Specifies entry sequence to the Installer Menu.

0 = 9876 1 = 4321
2 = 1478 3 = 3698

001 - POWER MANAGE (Power Management)

As an energy saving feature, this item determines the number of hours, in the range 1 to 7, of inactivity allowed, either at the TV control panel or from the remote, before the TV automatically turns itself OFF.

In addition to Power Management setting, values 8 to 15 determine the availability of the Force TV Reboot with IR Remote feature when Installer Menu item 002 AC ON is set to 1, 3, 17, or 19 (see also item 002 description). While the TV is ON, perform the following steps to force the reboot: 1) Press and hold the POWER key on the Installer Remote for at least five seconds, and then release it. 2) Within two seconds of releasing the POWER key, press the numeric key sequence 3-1-4 (you will have two seconds to press each numeric key). During the reboot process, the TV will initiate an update event (see also item 121 UPDATE TIME HR description). After reboot, the TV returns to its ON state.

See table below for all values. If set to 0 or 8, Power Management is disabled.

| Value | Power Mgmt | Force TV Reboot | Value | Power Mgmt | Force TV Reboot |
|-------|------------|-----------------|-------|------------|-----------------|
| 0 | Disabled | Disabled | 8 | Disabled | Enabled |
| 1 | 1 hour | Disabled | 9 | 1 hour | Enabled |
| 2 | 2 hours | Disabled | 10 | 2 hours | Enabled |
| 3 | 3 hours | Disabled | 11 | 3 hours | Enabled |
| 4 | 4 hours | Disabled | 12 | 4 hours | Enabled |
| 5 | 5 hours | Disabled | 13 | 5 hours | Enabled |
| 6 | 6 hours | Disabled | 14 | 6 hours | Enabled |
| 7 | 7 hours | Disabled | 15 | 7 hours | Enabled |

Note: Values 8 to 15 are applicable with PTC v1.00.013 (UT782V0UA and UT782V2UA models)/v1.00.008 (UT782V9UA models) or later.

002 - AC ON (AC Power Switchable)

Determines the status of the TV when AC power is applied. Set to 0 (default) for standard TV turn ON/OFF operation. Set to 16 if you would like the TV to turn ON the first time AC power is applied, after which the TV will be configured for standard ON/OFF operation.

If set to 1 or 17 (Always ON), the TV will turn ON when AC power is applied. Pressing the POWER button is not necessary. This is desirable if the TV is plugged into a switched AC outlet (i.e., a set-top box). Though note that if the Pro:Centric application is loaded (i.e., item 098 PRO:CENTRIC is not set to 0), the TV will reboot and initiate an update once every 24 hours.* During the update event, the TV checks for and downloads any available updates from the Pro:Centric server (item 119 DATA CHANNEL set from 1 to 135 or 253). The time at which this event occurs depends on the setting of item 121 UPDATE TIME HR. See item 119 and 121 descriptions for further information. Once the update cycle is complete, the TV completes the reboot and returns to its ON state.

Note: If set to 1 or 17, the TV does not respond to ON/OFF commands from either the remote or the display panel, and the Sleep Timer is also nonfunctional.

Set to 2, 3, 18, or 19 to enable the Instant ON feature, as required. The Instant ON feature allows the TV to turn ON when AC power is applied, but with video and audio muted (Muted ON). The TV remains powered ON while appearing to be OFF. Pressing the POWER button toggles off/on the video and audio mutes, so that the TV appears to turn ON instantly. Set to the appropriate value to enable Instant ON with reboot (value 2 or 18) or Instant ON without reboot (value 3 or 19), respectively. See bullets below for further information on reboot functionality. See also note below.

Note: Values 2 and 3 represent standard Instant ON functionality; i.e., when AC power is applied, the TV is in a Muted ON state. If set to 18 or 19, the Instant ON feature allows the TV to turn ON, without muting video and audio, when AC power is initially applied.

- Instant ON with reboot: The TV will reboot and, if applicable (i.e., item 119 DATA CHANNEL set from 1 to 135 or 253), check for and download any available updates from the Pro:Centric server at every turn OFF. This setting is not recommended if the TV will be configured with a resident application.
- Instant ON without reboot: The TV will not reboot to check for and download updates at turn OFF, with the following exception: the first time the TV is turned OFF after this item is set to 3 or 19, the TV will reboot and initiate an update event (Data Channel Auto Search and/or check for and download of updates—see also paragraph below). This setting is recommended if the TV will be configured with a resident application. In this mode, the standard check for and download of updates is under application control. Refer to your site-specific documentation for further information on configuring the TV with a resident application.

* Exception: If the TV is externally rebooted within the previous 24 hours, the subsequent update event will take place at the next designated reboot time, which could be up to 48 hours from the time of the external reboot.

When this item is set to 2, 3, 18, or 19, the TV also will reboot and initiate an update event once every 24 hours. During the update event, the TV, as applicable, performs a Data Channel Auto Search (item 119 set to 255) and/or checks for and downloads any available updates from the Pro:Centric server (item 119 set from 1 to 135 or 253). The time at which this event occurs depends on the setting of item 121 UPDATE TIME HR. See item 119 and 121 descriptions for further information. Once the update cycle is complete, the TV completes the reboot and returns to its Muted ON state.

Note: Instant ON is not supported when the TV is in MPI-EXT Mode.

003 - BAND/AFC (Tuning Band)

Selects the RF band used by the NTSC tuner:

0 = Broadcast 1 = Cable (default)
2 = HRC 3 = IRC

Determine the RF band used by the RF distribution system, and then select the appropriate value for this item before tuning channels or running Channel Tuning (Channel Search). See also item 102 ATSC BAND.

004 - STRT CHANNEL (Start Channel)

If active, this function allows you to determine the initial Major Start Channel number when the TV is turned ON. This feature is useful for an in-house information channel, since the TV would always select that channel when it is turned ON. If set to 255, the last channel tuned before the TV was turned OFF will be the channel tuned when the TV is turned ON again.

0 = Aux 127 = Map to Major CH 4
1 – 125 = Major Ch. # 253 = IP Start Channel
126 = Map to Major CH 3 255 = Last Channel

For a digital (ATSC) Start Channel, always remember to set item 104 to the Minor Start Channel number. If setting this item to 0 (Aux), make sure to also set item 046 STRT AUX SRCE to the appropriate value.

Note: 126 and 127 are mapped only in SONIFI PPV Mode.

Note: The IP Start Channel shown above can only be set in the Cloud Configuration Tool, which is typically used to configure TV CPUs for FTG Mode. The same applies for the additional Major Channel number range of 128–135 in Physical tuning and 128–999 in Virtual tuning mode. When the TV is in FTG Mode, the appropriate values will be visible in the (read-only) Installer Menu. For an IP Start Channel, item 004 will show value 253, the IP address, and the port number. For an RF Start Channel, item 004 will show the channel's Major and Minor numbers.

Note: If the TV is being configured for Application Tuning Mode operation with Pro:Centric Direct, the Start Channel is set in the Pro:Centric Direct Admin Client, and Installer Menu item 004 is automatically updated accordingly. When the TV is in Application Tuning Mode, the appropriate values will be visible in the (read-only) Installer Menu. For an IP Start Channel, item 004 will show value 253, the IP address, and the port number. For an RF Start Channel, item 004 will show the channel's Major and Minor numbers.

005 - CHAN LOCK (Channel Lock)

Channel Lock is ideal if the system must always be on the same channel. If set to 1, Channel Lock is enabled and it is not possible to change channels. If set to 0 (default), Channel Lock is disabled.

Generally, this feature is used in connection with item 004 STRT CHANNEL where the Start Channel may, for example, be set to 3 or 4. If the Start Channel is 3, then the TV will remain locked on channel 3.

NOTE: For items 007, 008, and 009

For legacy reasons, the scale used is 0–63. The PTC software will translate this to the 0–100 scale used by the TV.

To translate a TV volume level to the Installer Menu value, use the following formula:

$$\text{Installer Value} = \frac{\text{TV Value} \times 63}{100}$$

Enter only the whole number (disregard fractions).

007 - STRT VOLUME (Start Volume)

This function allows you to determine the initial volume level setting on the TV when it is turned ON. The range of values for this item is 0 to 63, 255. If set to 255, the last TV volume level before the TV was turned OFF will be the current volume level when the TV is turned ON again.

Note: The factory default TV volume level (i.e., when AC power is initially applied) for these TV models is 20. In addition, if AC power is removed/disconnected and then reapplied to the TV while this item is set to 255, the TV volume level will revert to 20 when the TV is turned ON again, with the following exceptions: for item 002 AC ON settings 16–19, the TV volume level will remain at the last volume level.

008 - MIN VOLUME (Minimum Volume)

This function determines the minimum volume level allowable with the Volume (VOL) Up/Down control. In this way, for example, someone cannot set the volume too low to hear. The value range for this item is from 0 to 63. The factory default is 0, which provides the full range of TV volume control, if item 009 MAX VOLUME is set to 63. It is recommended to set the same value on every TV.

Note: The minimum volume level cannot have a value setting higher than the maximum volume level (described below).

009 - MAX VOLUME (Maximum Volume)

This function determines the maximum volume level allowable with the Volume (VOL) Up/Down control. In this way, for example, someone cannot set the volume level high enough to disturb others. The value range for this item is 0 to 63, with 63 as the default, which provides the full range of TV volume control, if item 008 MIN VOLUME is set to 0. It is recommended to set the same value on every TV.

Note: The maximum volume level cannot have a value setting lower than the minimum volume level (described above).

Installer Menu (Cont.)

010 - MUTE DISABLE

Enables or disables the sound Mute function. If set to 1, sound cannot be muted. If set to 0, sound can be muted.

015 - SLEEP TIMER

If set to 1, the Sleep Timer feature is enabled and available to the end user. Set to 0 to disable the Sleep Timer feature.

016 - EN TIMER (Enable On/Off Timers)

If set to 1, the Timer function is enabled and available to the end user. Set to 0 to disable On/Off timers.

Note: The TV clock must be set in order for timers to be used.

017 - ALARM

If set to 1, the Alarm feature is enabled and available to the end user in the Function Menu (i.e., the TV is not in Pass-through Mode). Set to 0 to disable the Alarm feature.

Note: The TV clock must be set before the Alarm feature will work.

020 - FEATURE LEVEL

Determines an additional IR code scheme to which the TV will respond, allowing for the use of unique IR codes based on "bed number" in a multi-TV single room installation. First determine the IR mode; then select the bed number.

| Value | IR Mode | Bed # |
|-------|-------------------|-------|
| 0 | Disabled | N/A |
| 16–24 | Multi-code Remote | 1–9 |

Note: For further information, see documentation for the accessory package that includes the multi-code remote.

021 - V-CHIP (Parental Control)

Set to 1 to activate V-Chip (Parental Control) and have it available to the end user to filter and control or otherwise restrict programming content that can appear. Set to 0 to turn off the V-Chip feature (not available to end user); no programming restrictions can be set.

022 - MAX BLK HRS (Maximum Block Hours)

Sets hours from 0 to 99 for the maximum number of Parental Control blocking hours that can be set in the Function Menu (i.e., the TV is not in Pass-through Mode). Default setting is for 12 blocking hours.

Note: This item is not available in the Installer Menu when item 021 V-CHIP is set to 0 or when item 084 PERMANENT BLK is set to 1.

023 - CAPTION LOCK

If set to 0, captions are off when the TV is turned ON. If set to 1, the caption setting selected before the TV was turned OFF will be the current caption setting when the TV is turned ON again.

028 - CH. OVERRIDE (Channel Override)

This item either allows or restricts tuning of channels that are NOT in the PTC Channel Map. If set to 1, end users can tune channels that are not in the PTC Channel Map by direct keypad entry. If set to 0, end users are restricted to only the channels that are in the PTC Channel Map. In the case of CPU-CTV Mode, there are no channels in the PTC Channel Map; therefore, direct keypad entry is not available. Also, when this item is set to 0, the PTC Channel Map (PTC-CTV Mode)/CPU channel lineup (CPU-CTV Mode) is locked, and end user access to channel settings in the TV setup menus is restricted.

Note: This item is not applicable when the TV is in FTG Mode or Application Tuning Mode.

029 - REMAP AUX INPS

Set to 1 to remap the PTC's direct tune channels for Aux inputs from 13x to 9x. This allows 2-digit only tuning systems (i.e., legacy On Command Video™) to direct tune Aux inputs. See also Reference section, "TV Aux Input Configuration."

Note: This item is not applicable when the TV is in FTG Mode or Application Tuning Mode.

030 - EXTCTL/ACKMASK

Determines status of MPI ACK Mask feature, as well as availability of external control either via MPI (using MPI port) or via TLT (using RS-232C Control port). See table below.

Note: Values 2 to 5 (Ext Ctrl) are applicable with CPU v3.11.40 or later and PTC v1.00.011 (UT782V0UA and UT782V2UA models)/v1.00.006 (UT782V9UA models) or later.

| Value | External Control Port | | | | ACK Mask Feature |
|-------|-----------------------|-----------------|------------------------|-----------------|------------------|
| | CPU-CTV Mode | | CPU-FTG / CPU-P:C Mode | | |
| | MPI | RS-232C Control | MPI | RS-232C Control | |
| 0 | O | O | X | X | Disabled |
| 1 | O | O | X | X | Enabled |
| 2 | O | X | O | X | Disabled |
| 3 | O | X | O | X | Enabled |
| 4 | X | O | X | O | Disabled |
| 5 | X | O | X | O | Enabled |

O = Available X = Prohibited

031 - POLL RATE

MPI Communication Parameter. Selects the poll rate for MPI. Step size of 16 ms. Changing from default may affect communication via MPI.

032 - TIMING PULSE

MPI Communication Parameter. Sets the baud rate for MPI. Step size of 4.3 uS. Changing from default may affect communication via MPI.

035 - HDMI1 ENABLE

Set to 1 to enable HDMI 1 input in DTV Mode. Set to 2 to enable HDMI 1 input in PC Mode. Set to 0 to disable display panel HDMI 1 input.

039 - REAR AUX EN. (Rear Aux Enable)

Set to 1 to enable the display panel rear Aux (AV) input. Set to 0 to disable the display panel rear Aux (AV) input.

041 - SIMPLINK EN

Set to 0 to disable the SIMPLINK feature. Set to 1 to enable SIMPLINK functionality (does not enable remote control access to the SIMPLINK Menu).

Note: When both this item *and* item 042 AUTO INPUTS are enabled in the Installer Menu, HDMI inputs will be detected by SIMPLINK, but the Auto Input(s) Sensing Feature will not function.

Note: ARC functionality requires that SIMPLINK be enabled.

042 - AUTO INPUTS

Determines the Aux inputs for which auto-sensing is enabled. Set to 0 to disable auto-sensing for all available inputs. Set to 255 to enable auto-sensing for all available inputs. For information on options for individual input settings, see Reference section, "Auto Input(s) Sensing Feature."

Note: In order for auto-sensing to be enabled for an input, that input must also be enabled in the Installer Menu. For example, to enable auto-sensing for HDMI 1, item 035 HDMI1 ENABLE must also be set to 1 or 2. Also, see note above regarding TV operation when both this item and item 041 SIMPLINK EN are enabled.

046 - STRT AUX SRCE (Start Aux Source)

Sets the starting Aux source. When turned ON, the TV will tune to the starting Aux source if item 004 STRT CHANNEL is set to 0.

1 = AV 3 = HDMI 1 5 = HDMI 2
255 = Last Aux

Note: In order for an Aux input to be selected as the starting Aux source, the input also must be enabled in the Installer Menu.

Note: This item is not available in the Installer Menu unless item 004 STRT CHANNEL is set to 0.

047 - AUX STATUS

Controls the MPI status channel response for Aux sources. Set to 1 for the Aux source to be reported as its channel number. Set to 0 for the Aux source to be reported as channel 0. See Reference section, "TV Aux Input Configuration," for Direct Access channel numbers.

049 - DIS. AUDIO M. (Disable Audio Menu)

Determines the availability of the Sound Out (Audio) Menu in the TV menus. Also determines the default Audio Mode when TV is turned ON. See the table below and set as required.

| Value | Sound Out Menu Status | Default Audio Mode at TV Turn ON |
|-------------|-----------------------|----------------------------------|
| 0 (default) | Enabled | TV Speaker |
| 1 | Disabled | TV Speaker |
| 2 | Enabled | External Speaker (Optical) |
| 3 | Disabled | External Speaker (Optical) |
| 4 | Enabled | LG Sound Sync (Optical) |
| 5 | Disabled | LG Sound Sync (Optical) |
| 6 | Enabled | LG Sound Sync (Wireless/BT) |
| 7 | Disabled | LG Sound Sync (Wireless/BT) |
| 8 | Enabled | TV Speaker + Audio Out (Optical) |
| 9 | Disabled | TV Speaker + Audio Out (Optical) |
| 10 | Enabled | External Speaker (HDMI ARC) |
| 11 | Disabled | External Speaker (HDMI ARC) |

Note: Values 10 & 11 are only available if item 041 SIMPLINK EN is set to 1 (enabled).

Note: If a SIMPLINK-enabled device is connected to the TV and item 041 SIMPLINK EN is set to 1 (enabled), the SIMPLINK device Audio Mode will have priority over the setting of this item when the TV is turned ON.

053 - DIS. CH-TIME (Disable Channel-Time Banner)

Set to 1 to disable display of the TV's native Channel-Time banner when a custom channel label/channel information will be provided by the MPI command. Set to 0 to enable display of the TV's native Channel-Time banner.

Note: This item is not applicable when the TV is in FTG Mode or Application Tuning Mode.

069 - EN. CH-T COL. (Enable Display Characters Custom Color)

Set to 1 to enable custom color for MPI display characters. Set to 0 to disable custom color for MPI display characters.

070 - FOR. CH-TIME (Display Characters Foreground Color)

Set the foreground color for MPI display characters according to the following color chart:

0 = Black 2 = Green 4 = Red 6 = Yellow
1 = Blue 3 = Cyan 5 = Violet 7 = White

If the foreground and background colors for the display characters are the same, the background will be transparent.

Note: This item and item 071 BCK. CH-TIME also apply to the "Channel Not Available" message if item 073 CH NOT AVBLE is set to 1 (enabled).

Note: Items 070 FOR. CH-TIME and 071 BCK. CH-TIME are only available in the Installer Menu when item 069 EN. CH-T COL. is set to 1.

Installer Menu (Cont.)

071 - BCK. CH-TIME (Display Characters Background Color)

See description for item 070 FOR. CH-TIME above. The color chart is the same for both items.

073 - CH NOT AVBLE (Channel Not Available)

If set to 1 and item 028 CH. OVERRIDE is set to 0, a "CHANNEL NOT AVAILABLE" message is displayed when a user attempts to direct tune a channel that is not included in the channel lineup.

Note: This item is not available in the Installer Menu when item 028 CH. OVERRIDE is set to 1.

Note: This item is only applicable when the TV is in PTC-CTV Mode.

075 - REVERT CH (Revert to Start Channel)

If set to 1 and loss of MPI communication occurs, the TV automatically tunes to the specified Start Channel.

Note: This item is not available in the Installer Menu when item 004 STRT CHANNEL is set to 255. This item also is not available in the Installer Menu when item 004 STRT CHANNEL is set to 0 and 046 STRT AUX SRCE is set to 255.

078 - UPN MSB (UPN Most Significant Byte)

User programmable number, most significant byte readable by MPI command. **Note:** Not linked to serial number.

079 - UPN MSB-1 (UPN Most Significant Byte-1)

User programmable number, most significant byte-1 readable by MPI command. **Note:** Not linked to serial number.

080 - UPN MSB-2 (UPN Most Significant Byte-2)

User programmable number, most significant byte-2 readable by MPI command. **Note:** Not linked to serial number.

081 - UPN LSB (UPN Least Significant Byte)

User programmable number, least significant byte readable by MPI command. **Note:** Not linked to serial number.

082 - CHKSUM ERROR (Checksum Error)

Enforces rigid MPI checksum validation. Set to 1 for validation. Set to 0 to disable (does not check checksum on MPI async port). SPI is always checked.

083 - HANDSHK TIME (Handshake Time)

Determines the MPI timing requirement of the (STB's) MPI command to follow the end of the transmission of the (display's) MPI Status Response. Value range is 0 to 5. Changing from default may affect communication via MPI.
(Handshake Time = 25.5 ms + [25.5 ms x item value])

084 - PERMANENT BLK (Permanent Block)

Allows Parental Control blocking schemes to be permanent by disabling the end user's ability to limit blocking hours in the Function Menu. Set to 1 to install Parental Control restrictions permanently. Set to 0 for end user-specified hours control of blocking schemes. See also item 022 MAX BLK HRS.

Note: This item is not available in the Installer Menu when item 021 V-CHIP is set to 0.

088 - EN NOISE MUTE (Enable Noise Mute)

Applicable for analog channels only. If set to 1, audio mutes if no signal is present.

090 - KEY LOCK

If set to 1, Key Lock is enabled, which means that the display panel power button function is locked, i.e., non-functional. Set to 0 to disable Key Lock. **Note:** that all IR features remain functional regardless of this setting.

091 - HDMI2 ENABLE

Set to 1 to enable HDMI 2 input in DTV Mode. Set to 2 to enable HDMI 2 input in PC Mode. Set to 0 to disable display panel HDMI 2 input.

094 - SAP MENU EN (2nd Audio Program)

Set to 1 to enable the SAP feature in the Function Menu (i.e., the TV is not in Pass-through Mode). Set to 0 to disable the SAP feature in the Function Menu.

096 - DEF. ASP. RATIO (Default Aspect Ratio)

Selects the aspect ratio to be set as default each time the TV is turned ON:

| | |
|--------------------|---------------|
| 0 = Set By Program | 1 = 4:3 |
| 2 = 16:9 (default) | 3 = Just Scan |
| 4 = Zoom | |

Note: See also item 106 ASP RATIO LOCK. This item (i.e., item 096) is not available in the Installer Menu when item 106 is set to 1.

097 - AUDIO OUTPUT

- For UT782V0UA and UT782V2UA models: Determines availability and signal type/level (fixed speaker, variable speaker, or fixed line level) of the audio output to be used by external audio equipment connected to the SPEAKER OUT / LINE OUT jack on the TV. Set to 0 to disable audio output. Otherwise, see the table below and set as required in accordance with audio equipment. See also Reference section, "External Speaker/Audio Line Out Specifications."

| | Value | Status |
|--|-------|--|
| Speaker Output (typical 8Ω impedance) | 1 | Fixed 0.01 Watts |
| | 2 | Fixed 0.03 Watts |
| | 3 | Fixed 0.05 Watts |
| | 4 | Fixed 0.10 Watts |
| | 5 | Fixed 0.20 Watts |
| | 6 | Fixed 0.50 Watts |
| | 7 | Fixed 1.00 Watt (default) |
| | 8 | Control with volume |
| Line Output | 9 | Fixed line level (typically 400 mVrms ± 40 mVrms @10KΩ) output |

- For UT782V9UA models: Determines availability of the analog audio output to be used by external audio equipment connected to the AUDIO LINE OUT jack on the TV. Set to 0 to disable audio output. Otherwise, see the table below and set as required in accordance with audio equipment. See also Reference section, "External Speaker/Audio Line Out Specifications."

| | Value | Status |
|-------------|-------|--|
| Line Output | 9 | Fixed line level (typically 400 mVrms ± 40 mVrms @10KΩ) output |
| | 10 | Control with volume |

098 - PRO:CENTRIC

Selects the Pro:Centric Application Mode. Set to 0 (default) to disable the Pro:Centric application. Set to 2 for GEM (Java Application) Mode. Set to 3 for HTML Mode.

To initiate the Pro:Centric application download, the TV must be turned OFF/ON two times. Once you exit the Installer Menu, turn OFF the TV for at least one minute. When you turn the TV back ON, wait until TV programming appears on the display, and then turn the TV back OFF, this time for a few minutes, to initiate the application download. When you turn the TV back ON, press PORTAL on the Installer Remote, and verify that the Pro:Centric application appears on the display.

Note: This item is not available in the Installer Menu when item 119 DATA CHANNEL is set to 0.

099 - BACK LIGHTING

Sets the TV screen brightness. Default setting is 255.

- 1 (dimmest picture)– 100 (brightest picture) Static Back Lighting
- 101 (dimmest picture)– 200 (brightest picture) Dynamic Back Lighting: The TV automatically controls back lighting depending upon the picture level of the current program.
- 201 Automatic Static Back Lighting: The TV automatically controls back lighting by using Intelligent Sensor to detect the level of ambient lighting.

- 202 Automatic Dynamic Back Lighting: The TV automatically controls back lighting by using Intelligent Sensor to detect the level of ambient lighting and depending upon the picture level of the current program.

If set to 201 or 202, back lighting can be controlled via the Picture settings in the TV setup menus. However, each time the TV is turned ON, Picture Mode (set in Picture Menu) is defaulted to Intelligent Sensor. If Picture Mode is manually set to a static option (Vivid, Standard, etc.) during a viewing session, Intelligent Sensor is temporarily disabled.

If set to 255, back lighting is controlled via the Picture settings in the TV's setup menus.

101 - IR FEEDBACK

If set to 0 (default), the TV's MMR (Magic Motion Remote) feature is enabled, and a compatible LG MMR (not supplied) may be used with the TV. If set to 2, the MMR feature is disabled.

102 - ATSC BAND

Selects the RF band used by the ATSC tuner.

0 = Broadcast 1 = Cable 2 = HRC
3 = IRC 4 = Same as NTSC (default)

103 - ATSC TUNE MODE

Sets the ATSC tuning mode. Set to 1 (default) for Physical Channel tuning. Set to 0 for Virtual Channel tuning.

Note: This item must be set to 1 (Physical Channel tuning) to support Pro:Centric RF data channel operation. See also item 119 DATA CHANNEL.

104 - START MINOR CHANNEL

When a digital (ATSC) Start Channel has been specified for item 004 STRT CHANNEL, this item sets the Minor Start Channel number. Set to 0 when an analog (NTSC) Start Channel has been specified for item 004.

Note: This item is not available in the Installer Menu when item 004 STRT CHANNEL is set to 0 or 255.

106 - ASP RATIO LOCK (Aspect Ratio Lock)

Set to 0 to use the default aspect ratio each time the TV is turned ON (see item 096 DEF. ASP. RATIO). If set to 1, the aspect ratio set before the TV was turned OFF will be the current aspect ratio when the TV is turned ON again.

107 - BANNER SELECT

Selects the type of native Channel-Time banner to display during channel change. Set to 1 for channel label display, plus channel information (full banner). Set to 0 for channel label display only (small banner). See also item 053 DIS. CH-TIME.

116 - VIDEO MUTE EN (Video Mute Enable)

Applicable for analog channels only. If set to 1, video mutes (blank screen) when no signal is present.

Installer Menu (Cont.)

117 - FACT DEFAULT (Factory Default)

Set to 1 and press OK to restore the factory default settings of all Installer Menu items. Once complete, the value returns to 0.



Caution: If set to 1, this clears all Installer Menu custom settings and restores the factory default settings. It also clears the channel lineup, including any assigned channel icons and custom text labels.

Note: See also Reference section, "Restoring Factory Defaults on the TV(s)," for further information.

119 - DATA CHANNEL

Set to 0 to disable. Set from 1 to 135 to match the (physical) RF channel number that will be used by the Pro:Centric server as its data channel. If left at or set to (default value) 255, the TV's Data Channel Auto Search feature will be enabled. See additional information below.*

Data Channel Auto Search

When this item is set to 255 (default), once every 24 hours, the TV attempts to find an active Pro:Centric server.

- If connected to an IP network, the TV will first check for a "procentric.local" DNS entry. If the Pro:Centric server IP address is obtained from a DNS server, the DATA CHANNEL value will be changed from 255 to 253, which designates an IP data channel.

Note: The automated IP configuration feature requires a "procentric.local" DNS entry, which enables the Auto Search to obtain the Pro:Centric server's IP address. This feature also expects the Pro:Centric server's port number to be set to "80."

- If an IP data channel is not found, the TV searches for an RF data channel. The TV will initiate a search of 10 predefined RF channels (10, 20, 30, ... 100) and then, if necessary, perform a complete search of the RF channels (1 to 135). If the Pro:Centric RF channel is found, the DATA CHANNEL value will be changed from 255 to match the server's RF channel number.

The time at which the Auto Search occurs depends on the setting of item 121 UPDATE TIME HR. See item 121 description for further information.

Note: Pro:Centric updates are downloaded from the Pro:Centric server to the TV when the TV is turned OFF. While Pro:Centric updates are in progress, it is not possible to turn ON the TV.

Note: The Data Channel value also is automatically set to "253" if Media Type is set to "IP" either in the Solution Settings / EZ-Manager Wizard (see "Solution Settings / EZ-Manager Wizard" on pages 25 to 36) or in the IP Environment / Pro:Centric Menu (see "Pro:Centric Setup" on pages 75 to 78) on the TV or if Installer Menu item #119 Data Channel is set to "IP Address" or "IP Domain Name" in the Cloud Configuration Tool, which is typically used to configure TV CPUs for FTG Mode operation. It is not possible to change the value to "253" directly in the Installer Menu.

121 - UPDATE TIME HR

Based on the settings of this item and item 122 UPDATE TIME MN, the Wake For Update feature wakes the TV once daily to check for and, if applicable, download updates from the Pro:Centric server.

Set the Wake For Update hour from 0 to 23. This item uses the 24-hour clock format. The default value (128) is displayed as "DFT," which means Default Time. Directly entering "128" resets the default value (Default Time) for this item. See additional information below.

Under standard TV OFF/ON operating conditions (i.e., item 002 AC ON is set to 0), a Wake For Update event occurs when the TV is OFF and causes the TV's CPU to temporarily turn ON, perform the update cycle, and then turn back OFF, all while the TV appears to be OFF. If item 002 AC ON is set to 2, 3, 18, or 19 for Instant ON, then the TV's CPU is always ON and Wake For Update occurs when the TV is in its Muted ON state (i.e., the TV only appears to be OFF). The Wake For Update event causes the TV's CPU to reboot in order to perform the update cycle and then return to its Muted ON state. See also description for item 002.

Random Distribution of Update Time: If this item is set to 128 (Default Time), the time at which a Data Channel Auto Search (item 119 set to 255) and/or an Instant ON update (item 002 set to 2, 3, 18, or 19) occurs is determined as follows: Each TV initiates the search and/or checks for updates during the 2 AM hour (if the TV clock is set) or after two hours of elapsed time from when AC power was applied (if the TV clock is not set). Also, in this case, a fixed update time minute from 0 to 59 that has been assigned to each TV is used. (The intention of this feature is to prevent all of the installed TVs from performing updates at the same time; however, note that in installations that have a large quantity of TVs with this feature, there will be some TVs that have the same update minute assignments.) The update time for the TV is displayed at the right of this item in the Installer Menu, for example:

121 UPDATE TIME HR DFT [02:34]

If the TV display is ON when a Wake For Update event is to occur, the update will take place the next time the TV is turned OFF.



Caution: UPDATE TIME HR should NEVER be set to 255 (PREVENT). This setting is intended for factory use only.

Note: Brackets are only shown around the DFT (Default Time) setting. Any other time value for this item will not be shown with brackets.

Note: This item is not available in the Installer Menu when item 119 DATA CHANNEL is set to 0, except when item 002 AC ON is set to 2, 3, 18, or 19 for Instant ON. In addition, this item is not available in the Installer Menu when item 002 AC ON is set to 1, unless item 098 is not set to 0.

Note: The TV clock must be set in order for a Wake For Update event to occur at the precise time of day in accordance with item 121 and item 122 settings.

* PCS150R and later Pro:Centric servers do not support HRC or IRC cable channel frequencies.

122 - UPDATE TIME MN

Set the Wake For Update minute from 0 to 59. If item 121 is NOT set to 128 and you wish to invoke the "random" minute assignment on the TV, set this item to 255. See also description for item 121 UPDATE TIME HR above.

Note: This item is not available in the Installer Menu unless item 121 UPDATE TIME HR is set from 0 to 23.

Note: The TV clock must be set in order for a Wake For Update event to occur at the precise time of day in accordance with item 121 and item 122 settings.

Custom Master TV Setup

This section describes how to create a customized Master TV Setup for cloning purposes when the TV is in Pass-through Mode. All cloning (export and import) processes on the TV are performed via USB memory device / “.tlx” file. The Master TV Setup may be exported to a Clone (.tlx) file, which can then be used (i.e., imported) to configure either TVs that are to remain in Pass-through Mode or TVs that are to be configured for FTG Mode.

Cloning requirements and procedures are described in detail on pages 57 to 63.

Note: You can also use the Cloud Configuration Tool to create an FTG Configuration (.tlx) file for FTG Mode configuration/cloning purposes, if desired (see pages 64 to 66). However, it is not possible to customize TV setup menu settings in the Cloud Configuration Tool. If you wish to include customized TV setup menu settings in the TV configuration, in addition to the channel lineup and Installer Menu settings, perform the Master TV Setup procedure to create a Clone (.tlx) configuration file.

Before You Begin

- It is recommended that you disconnect all Aux inputs if you intend to run Channel Tuning (Channel Search). Under certain conditions, Channel Tuning is disabled if there is an Aux input active.
- A Clone (.tlx) file comprises Installer Menu settings, IP Environment Menu settings (with the exception of unique TV attributes and settings), and all TV sources’ (analog, digital, AV, HDMI, etc.) clonable setup menu settings. See also “Clonable TV Setup Menu Features” list below.
- If the “.tlx” file (either a Clone or FTG Configuration file) to be imported on the Target TV(s) contains an FTG Channel Map, the Target TV(s) will be configured for FTG Mode, though as part of the import process, depending on the types of channels included in the Channel Map, you may have the option to select either logical or physical channel tuning. If you would like the Target TV(s) to remain in Pass-through Mode, the “.tlx” file should not include an FTG Channel Map.

Clonable TV Setup Menu Features

| | | |
|--|--|--|
| <p>Picture Picture Mode Settings</p> <p>Sound Sound Mode Settings Additional Settings – Volume Mode – AV Sync Adjustment</p> | <p>Channels Channel Tuning Channel Manager Channel Label</p> <p>General Language Time & Date – Clock Mode (Auto/Manual) – Time Zone Timers (No Signal Power Off) Standby Light</p> | <p>Accessibility Audio Guidance Pointer Options Menu Transparency Closed Caption TV Power Sound High Contrast</p> |
|--|--|--|

Note: Some menu options vary between analog and digital channels and Aux inputs.

Note: The Quick Settings Menu is initially displayed when you press **MENU SETTINGS** on the Installer Remote. Select the **All Settings**  menu icon to access the advanced TV setup menus. Several advanced settings are duplicated in the Quick Settings Menu.

Custom Master TV Setup Procedure

1. Turn ON the TV.

The next step depends on whether the First Use Wizard appears on the screen when you turn ON the TV:

- If the wizard is displayed, the TV is in the required factory default state. Exit the wizard, and then continue with step 2.
- If the wizard is not displayed, restore the TV to a factory default condition before continuing with this procedure. See Reference section, “Restoring Factory Defaults on the TV(s),” as necessary, for further information.

2. Set Installer Menu items.

This step provides specific instruction only on the Installer Menu items that should be set on a Master TV. Refer to pages 42 to 53 for detailed information on all Installer Menu items.

- Use the Installer Remote to access the Installer Menu (see “Accessing the Installer Menu” on page 42 for further information).
- Set Installer Menu item **003 BAND/AFC**, as appropriate.
 - Broadcast: Set to 0.
 - Cable: Set to 1 (default).
 - HRC: Set to 2.
 - IRC: Set to 3.
- Set any other Installer Menu items as necessary, per installation/property requirements. For example, enable/disable Aux inputs, set a Start Channel, etc.
- After you have adjusted all Installer Menu item settings as required, and if you do not need to configure any IP Environment settings (see note below), press **OK** once on the Installer Remote to save your changes; then, press **OK** again to exit the menu.

Note: If you intend to configure settings in the IP Environment Menu, which is accessible from the Installer Menu, you can proceed directly to step 3. All Installer Menu settings will be saved automatically when you access the IP Environment Menu.

3. Configure IP Environment settings.

Note: You cannot return directly to the Installer Menu from the IP Environment Menu; thus, you may wish to set all Installer Menu items as needed before you access the IP Environment Menu. Otherwise, you will need to reaccess the Installer Menu to set additional items.

Navigate to Installer Menu item 119 DATA CHANNEL, and press **2-5-3 + MENU SETTINGS** to launch the IP Environment Menu. Then, complete network configuration as required. In particular, if you intend to use the Wi-Fi Zoning feature, you must configure the wireless network connection as part of the Master TV Setup. See “IP Environment Setup” on pages 70 to 83 for further information.

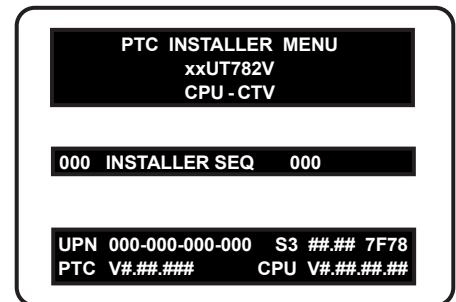

Typical Installer Menu



Adjust the value for this Installer Menu item, as required.

(Continued on next page)

Custom Master TV Setup (Cont.)

(Continued from previous page)

4. Set up TV features.

On-screen setup menus control the features of the TV. Press **MENU SETTINGS** on the Installer Remote, and select the **All Settings**  menu icon from the Quick Settings Menu to access the advanced TV setup menus. Then, set Picture, Sound, Channels, etc. options to the desired configurations. See “Clonable TV Setup Menu Features” list on page 54 and also notes below.

Note: If you intend to use the Zoning feature(s) on this TV, make sure to set the appropriate TV Zone # and/or Wi-Fi Zone # at this time as described in Reference section, “Using the TV’s Zoning Features.”

Note: If desired and if appropriate, you can run Channel Tuning (see step 5) prior to completing this step.

5. (Optional) Run Channel Tuning.

If you are creating a Master TV Setup for cloning purposes and you want the Target TV(s) to remain in Pass-through Mode or Application Tuning Mode, as applicable, do NOT run Channel Tuning. If you export a Master TV Setup that includes an auto-tuned/edited channel lineup, thereby creating a Clone (.tlx) file with an FTG Channel Map, and then import the Clone file to a Target TV, this will put the Target TV in FTG Mode.

Note: When you import a Clone/Configuration (.tlx) file that contains an FTG Channel Map on a Target TV (for FTG Mode configuration), depending on the types of channels included in the Channel Map, you may have the option to select either logical or physical channel tuning. For either selection, the channel sequence will be based on the order in which the channels appear in the FTG Channel Map. You can view and/or edit the channel sequence in the Cloud Configuration Tool, as required.

- a) Use the Installer Remote to access the Channels Menu. Then, select **Channel Tuning** and follow the on-screen instructions to search for all available digital and analog channels.
- b) Use the **Channel Manager** option in the Channels Menu to edit the channel lineup, as necessary. Add/delete channels per your system requirements.

6. Verify the TV setup.

Make sure the TV features are set per your requirements. Also, if applicable, verify that the channel lineup is correct.

The Master TV Setup is now ready to be saved (exported) to a USB memory device. See “Cloning Procedures” on pages 57 to 63.

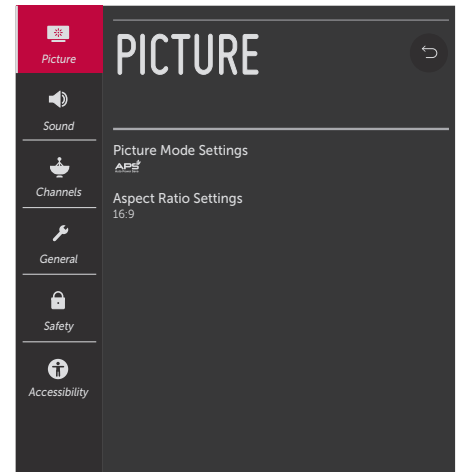

Use the TV setup menus to set the TV features to the desired configuration for the end user. This example illustrates the advanced TV setup menus.

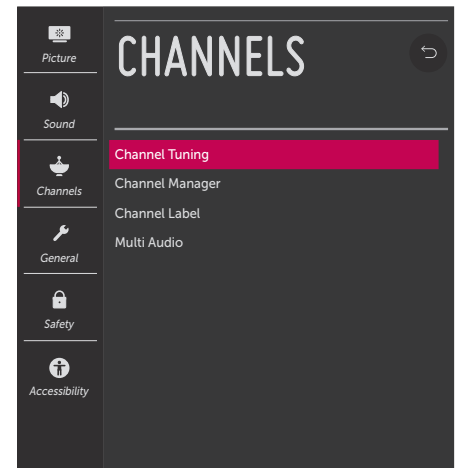

(Optional) Use Channels Menu options to run Channel Tuning and edit the channel lineup.

Cloning typically refers to the process of using a Master TV Setup to configure a Target TV. This section describes how to save (export) a Master TV Setup and then transfer (import) it to a Target TV using a USB memory device / Clone (.tlx) file.

You can also create an FTG Configuration (.tlx) file using the Cloud Configuration Tool and then use the Import Clone File procedure to transfer the configuration to Target TVs. Refer to “Creating an FTG Configuration File” on pages 64 to 66, as necessary.

Exporting a Clone File

This section describes how to use the TV Manager “Export Clone File” option to export Master TV Setup configuration to a USB memory device / Clone (.tlx) file.

Before You Begin

- Ensure the USB device has been formatted with FAT format.
- If applicable, complete the Custom Master TV Setup procedure (see pages 54 to 56).
- If you would like the Target TV(s) to remain in Pass-through Mode or Application Tuning Mode, as applicable, after the Clone file is imported, ensure the Master TV does not have an auto-tuned/edited channel lineup; otherwise, importing the exported file will result in the Target TV(s) being configured for FTG Mode.
- If you intend to use the TV's Zoning feature(s), make sure to set the appropriate TV Zone # and/or Wi-Fi Zone # as described in Reference section, “Using the TV's Zoning Features,” BEFORE performing the procedure below. Also, for Wi-Fi Zoning in particular, the TV's wireless network connection settings should be configured in the IP Environment Menu before exporting is initiated.
- It is not possible to clone a Master TV's clock. Either set a Target TV's clock manually, or use the Auto Clock setting in the TV setup menus.



Caution: Do not unplug the TV power cord or remove the USB memory device while exporting is in progress, as doing so may cause the TV to malfunction or harm the USB device, respectively.

Export Clone File Procedure

1. Ensure the Master TV is set up completely and turned ON.
2. Insert the USB memory device into either of the USB ports on the Master TV.
3. Press **MENU SETTINGS** on the Installer Remote to display the TV setup menus (TV is in Pass-through Mode) or the Function Menu (TV is already in FTG Mode).
4. (TV in Pass-through Mode only) From the Quick Settings Menu displayed at the left of the screen, select the **All Settings**  menu icon and press **OK** to access the advanced TV setup menus.
5. Use the arrow navigation keys to select/highlight either the **General** menu icon from the TV setup menus or the **Safety** menu icon from the Function Menu. Then, press the number “7” key a total of seven times to access the TV Manager.

(Continued on next page)

Cloning Procedures (Cont.)

(Continued from previous page)

Note: Ez Download is always selected by default when you initially access the TV Manager. Also, note that Diagnostics is for service use only.

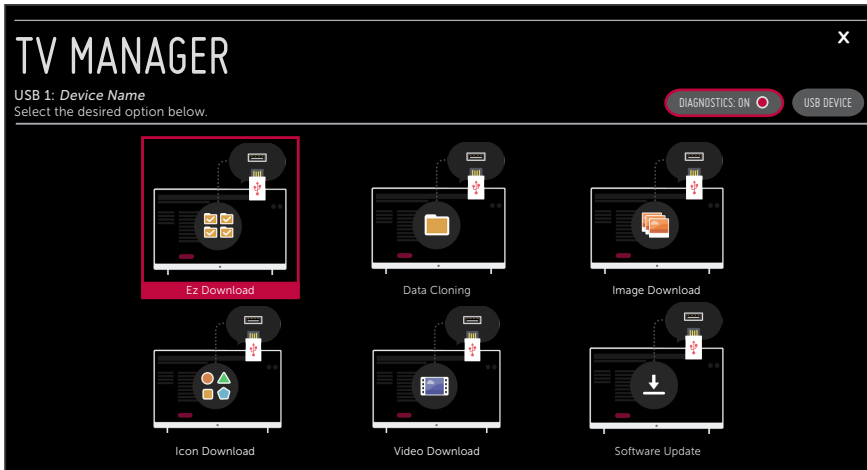

6. If more than one USB memory device is currently connected to the TV, be sure to select the USB device on which you wish to save the Clone file. If necessary, use the arrow keys on the Installer Remote to select/highlight the **USB DEVICE** button in the top right corner of the screen and press **OK**. Then, use the Up/Down arrow keys to select the appropriate USB device from the pop-up list of USB devices.

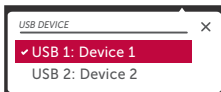

7. Use the arrow keys to select **Data Cloning**, and then press **OK**.
8. With the Data Cloning screen on display, key in the following number sequence on the Installer Remote: **9-8-7-6**. This will provide access to the "Export Clone File" option in the TV Manager (see example on following page).
9. Use the Up/Down arrow keys to select **Export Clone File**, and then press **OK**.
Clone filename parameters will be displayed on the screen.
10. Modify the filename, as required. While the TV model element of the filename may not be changed, you can differentiate this Clone file from other UT782V Clone files by changing the numeric assignment appended to the end of the filename. Select/highlight the filename, and then use the Up/Down arrow keys on the Installer Remote to scroll through numeric assignments until the desired number is shown.
11. When you are ready to continue, i.e., when you have selected the desired filename, press **OK** on the Installer Remote to select/activate the **EXPORT** button at the top right of the screen, and then press **OK** on the Installer Remote once more to export the file.

(Continued on next page)

(Continued from previous page)

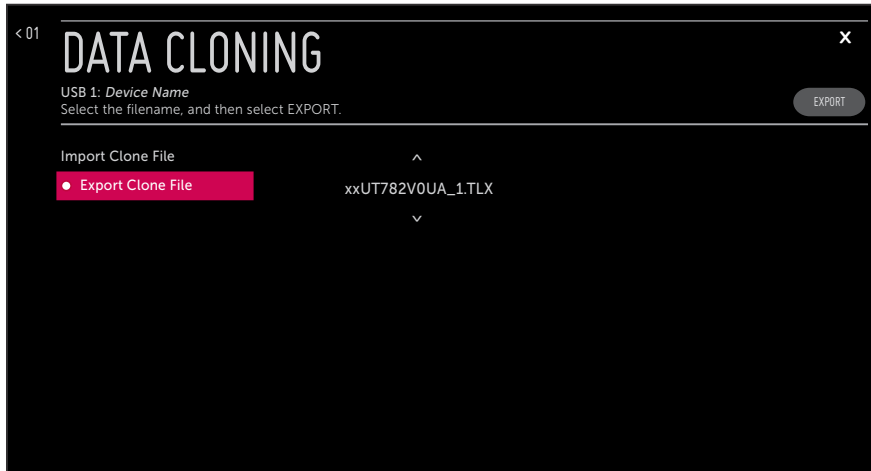

Export progress will be displayed on the screen. This process may take a few minutes. Do NOT remove the USB device while exporting is in progress. When the export process is complete, an “Export Clone File is completed” pop-up message will be displayed on the screen.

12. Press **OK** to return to the TV Manager / Data Cloning screen. To return to program viewing, select the **X** button at the top right corner of the screen.
13. Remove the USB memory device from the Master TV.

⚠ Note: If the Master TV has a channel lineup, during the export process, logical channel numbers are automatically assigned in ascending order, starting with 0 (zero), to the physical RF channels of the TV channel lineup to create an FTG Channel Map. See also note below.

⚠ Note: If the exported Clone file is to be used for FTG Mode configuration (i.e., it contains an FTG Channel Map), it is highly recommended that you open the file in the Cloud Configuration Tool—BEFORE transferring (importing) the file to any Target TVs—to verify FTG Channel Map and FTG Installer Menu settings. This will also enable you to confirm channels and add channel attributes, labels, etc.

Importing a Clone File

This section describes how to transfer (import) a Clone or Configuration (.tlx) file from a USB memory device to a TV using the TV Manager “Import Clone File” option. The “.tlx” file may be created either from a Master TV Setup that was saved (exported) from a Master TV or in the Cloud Configuration Tool.

Before You Begin

- Ensure the USB device has been formatted with FAT format.
- Avoid using special characters, such as ?, &, @, etc., in the Clone/Configuration (.tlx) filename.

(Continued on next page)

Cloning Procedures (Cont.)

(Continued from previous page)

- If you have initiated the Solution Settings / EZ-Manager Wizard, you can use the wizard's "USB Configuration" option to access the TV Manager and complete the import procedure (see "TV Configuration Options" and/or "USB Configuration" on pages 25 and 34, respectively, as necessary).
- You may also use the Ez Download utility to import the Clone/Configuration (.tlx) file. See "Ez Download Utility" on pages 37 to 41 for further information.
- If the Target TV is currently in Pass-through Mode and you intend to use the TV's Zoning feature(s)—i.e., the Clone/Configuration (.tlx) file you are importing contains an FTG Channel Map and/or FTG profile(s) with TV Zone and/or Wi-Fi Zone assignments—make sure to set the appropriate TV Zone # and/or Wi-Fi Zone # in the TV when directed to do so in the procedure below. See Reference section, "Using the TV's Zoning Features," for further information.
- If you would like the Target TV(s) to remain in Pass-through Mode or Application Tuning Mode, as applicable, after the Clone/Configuration (.tlx) file is imported, ensure the ".tlx" file does not contain an FTG Channel Map; otherwise, the import procedure will result in the Target TV(s) being configured for FTG Mode.
- If a Clone (.tlx) file (exported Master TV Setup) contains an FTG Channel Map, the physical RF channels in the FTG Channel Map have been assigned logical channel numbers (see "Exporting a Clone File" above). When you import the Clone file with the FTG Channel Map on the Target TV(s), you will have the option to select either logical or physical channel tuning. Even if you select physical channel tuning, the (list of) physical RF channels in the FTG Channel Map will remain in logical order.
- If an FTG Configuration (.tlx) file (created in the Cloud Configuration Tool) contains an FTG Channel Map, each logical channel number in the FTG Channel Map has been assigned a physical RF channel, an IP channel, or an Aux input (the latter designated by 130-0 through 137-0—see also Reference section, "TV Aux Input Configuration").

Note: If the FTG Channel Map includes RF channels and Aux inputs *only*, when you import the FTG Configuration file on the Target TV(s), you will have the option to select either logical or physical channel tuning. If you select physical channel tuning, the physical RF channels and Aux inputs in the FTG Channel Map will remain in logical order. Physical channel tuning is not available when the FTG Channel Map includes IP channels.

- If the Clone/Configuration (.tlx) file was edited/created in the Cloud Configuration Tool, it may contain multiple zoned FTG Installer Menu profiles for different TV models. Make sure it includes the appropriate Installer Menu profile(s) for the Target TV(s) before performing the procedure below.



Caution: Do not unplug the TV power cord or remove the USB memory device while importing is in progress, as doing so may cause the TV to malfunction or harm the USB device, respectively.

Import Clone File Procedure

1. Turn ON the Target TV.
2. The next step depends on whether the First Use Wizard appears on the screen when you turn ON the TV:
 - If the wizard is displayed, you can complete the import procedure via the Solution Settings / EZ-Manager Wizard, as indicated above (see “Before You Begin”). However, to continue with this procedure and access the “Import Clone File” option from the TV menus, exit the First Use Wizard. Then, continue with step 3.
 - If the wizard is not displayed, go directly to step 3.
3. If applicable (see also “Before You Begin” above), make sure to set the appropriate TV Zone # and/or Wi-Fi Zone # in the Target TV at this time.



Note: In order for the proper TV Zone and/or Wi-Fi Zone profile data to be applied, the appropriate TV Zone # and/or Wi-Fi Zone # must be set in the Target TV BEFORE importing is initiated.

4. Insert the USB memory device with the Clone/Configuration (.tlx) file into either of the USB ports on the Target TV.
5. Press **MENU SETTINGS** on the Installer Remote to display the TV setup menus (TV is in Pass-through Mode) or the Function Menu (TV is already in FTG Mode).
6. (TV in Pass-through Mode only) From the Quick Settings Menu displayed at the left of the screen, select the **All Settings**  menu icon and press **OK** to access the advanced TV setup menus.
7. Use the arrow navigation keys to select/highlight either the **General** menu icon from the TV setup menus or the **Safety** menu icon from the Function Menu. Then, press the number “7” key a total of seven times to access the TV Manager.

Note: Ez Download is always selected by default when you initially access the TV Manager. Also note that Diagnostics is for service use only.

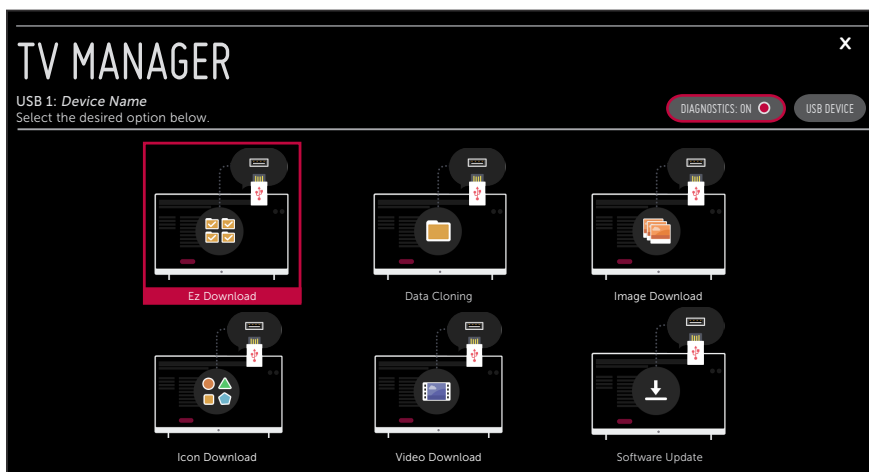

(Continued on next page)

Cloning Procedures (Cont.)

(Continued from previous page)

- If more than one USB memory device is currently connected to the TV, be sure to select the USB device that contains the “.tlx” file you wish to use. If necessary, use the arrow keys on the Installer Remote to select/highlight the **USB DEVICE** button in the top right corner of the screen and press **OK**. Then, use the Up/Down arrow keys to select the appropriate USB device from the pop-up list of USB devices.

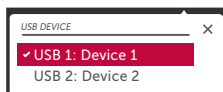

- Use the arrow keys to select **Data Cloning**, and then press **OK**.

When the Data Cloning screen is initially displayed, the “Import Clone File” option is selected by default, and a list of the “.tlx” files stored in the root folder of the USB memory device is displayed on the screen.

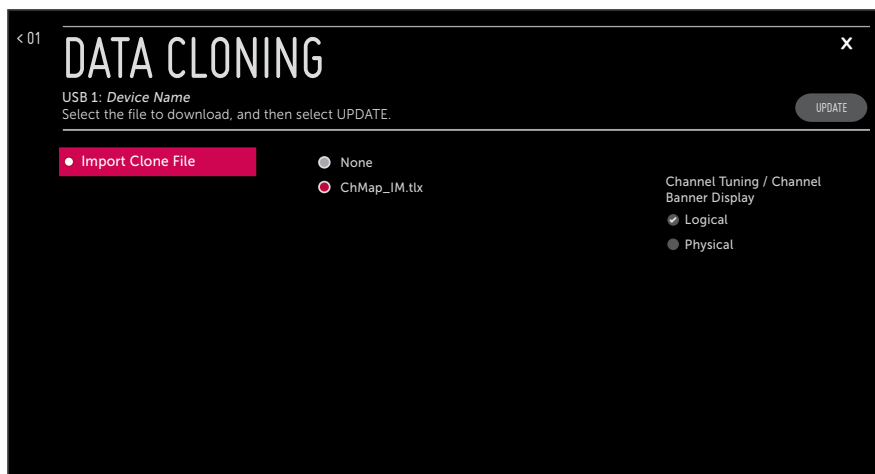

- Use the arrow keys on the Installer Remote to select/highlight the “.tlx” file to import, and then press **OK**.

Note: Filenames of exported Clone files are comprised of the TV model and a numeric element, for example, xxUT782V0UA_1.TLX.

- If the Clone/Configuration (.tlx) file includes an FTG Channel Map with RF channels and Aux inputs *only*, you can choose the format for the channel tuning/banner display. Use the arrow keys to select the desired Channel Tuning / Channel Banner Display option—either Logical or Physical—at the right side of the screen. A checkmark will appear at the left of the selected option. Logical tuning is selected by default.

Note: If an FTG Channel Map includes IP channels, only logical tuning is available. Also, if the “.tlx” file does not include an FTG Channel Map, the message, “No Channel Map in Clone file,” will be displayed at the right of the screen.

(Continued on next page)

(Continued from previous page)

12. When you are ready to continue, select **UPDATE** on the screen and then press **OK** on the Installer Remote.

Import progress will be displayed on the screen. This process may take a few minutes. Do NOT remove the USB device while importing is in progress. When the import process is complete, an "Import Clone File is completed" pop-up message will briefly be displayed on the screen, and then, the TV will reboot.

13. Remove the USB memory device from the Target TV, and verify that the appropriate configuration is now resident on the Target TV.

Note: If the Target TV was previously in Pass-through Mode, and the Clone/Configuration (.tlx) file that was imported contained an FTG Channel Map, the Target TV CPU is now in FTG Mode. Upon restart, the TV tunes according to the Start Channel setting in the Installer Menu. If a Start Channel is specified, the TV will tune to that channel, though, in the case of FTG Mode configuration, a channel banner will only be displayed if the Start Channel is included in the FTG Channel Map (depending on your selection in step 11, the channel banner will display either the Start Channel's logical channel number or physical RF channel number). Otherwise, the TV will either return to the last channel tuned (TV in Pass-through Mode) or tune to the first channel in the FTG Channel Map (TV in FTG Mode). If the latter, remember that the channels in the FTG Channel Map are always arranged in logical order, regardless of your selection in step 11.

Cloud Configuration Tool Overview

This section provides an overview of LG's Cloud Configuration Tool web application, which is used for FTG Mode configuration. For best results, it is recommended that you access the Cloud Configuration Tool using one of the following web browsers: Google Chrome™ 51 or later or Mozilla Firefox® 47 or later.

Creating an FTG Configuration File

The subsections below briefly describe how to use the Cloud Configuration Tool to create an FTG Configuration (.tlx) file that can be used to configure the TV for FTG Mode. The Cloud Configuration Tool provides options both for advanced and new users. If you are not familiar with the steps to create an FTG Configuration file, you may choose a Wizard Setup that will guide you through the process of creating a new file. Refer to the **Cloud Configuration Tool User Guide** for further information.

Note: There is also an option to save (export) configuration from a TV, which may be desirable or required if you want to save customized TV setup menu settings to the FTG Configuration file and/or if you do not know the RF channels at the site. See “Exporting a Clone File” on pages 57 to 59 for further information.

Access the Cloud Configuration Tool and Select a Setup Option

1. Launch a web browser, and navigate to the following URL: **cct.procentric.tv**.
2. On the Welcome web page, make sure **North America** (default) is selected in the Select Your Region field, and then click on the **SELECT** button at the right of the field.

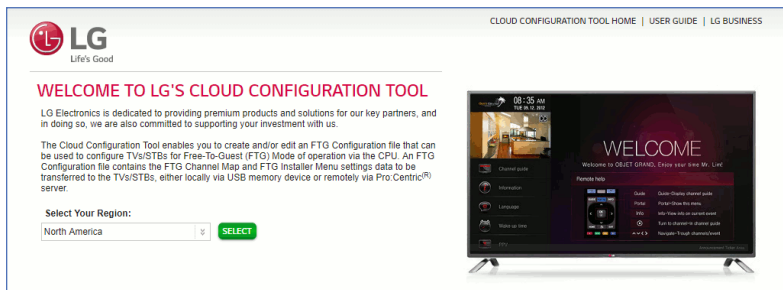

3. Once you select your region, you can choose the desired setup option, depending on your familiarity with the utilities and/or your file requirements:

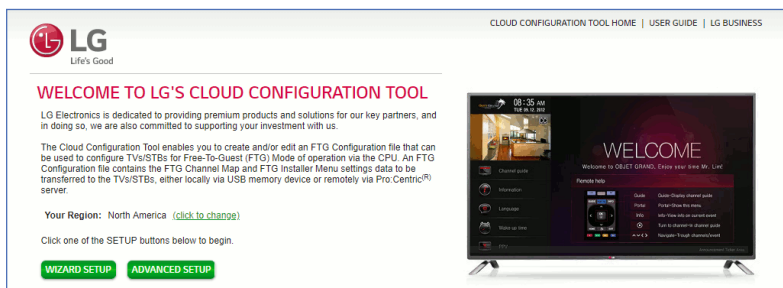

(Continued on next page)

Cloud Configuration Tool Overview (Cont.)

(Continued from previous page)

- If you are creating an FTG Configuration file from scratch and this is your first time using the Cloud Configuration Tool, you may wish to select the Wizard Setup, which will guide you through the essential steps of creating the file, i.e., creating the FTG Channel Map and/or the Installer Menu profile(s). To initiate the Wizard Setup, click on the **WIZARD SETUP** button.

On the next wizard page you will be prompted to indicate whether you would like to create an FTG Channel Map. Note that an FTG Channel Map is required for FTG Mode operation. Once you complete (or bypass) Channel Map activities and proceed to the next step, you will be prompted to indicate whether you would like to create an Installer Menu profile. The final wizard step enables you to review a summary of the FTG Configuration (.tlx) file contents and then save (export) the file to your PC.

- To view and/or base a new FTG Configuration file on an existing FTG Configuration (.tlx) file, or if you do not require wizard guidance to complete your activities, click on the **ADVANCED SETUP** button.

The File Manager web page will be displayed, and you have a number of options.

The following procedure provides an overview of the Advanced Setup. Refer to the **Cloud Configuration Tool User Guide** for further information on both the Wizard Setup and the Advanced Setup.

Advanced Setup Overview

1. When you select **ADVANCED SETUP** from the Welcome page (see “Access the Cloud Configuration Tool and Select a Setup Option” above), the File Manager page is displayed (see example on page 67).
2. (Optional) If desired/appropriate, you may view and/or base the new FTG Configuration file on an existing FTG Configuration (.tlx) file:

- Click on the **BROWSE** button at the right of the Find File to Upload field, and select/double-click on the desired “.tlx” file. Then, click on the **UPLOAD** button below the Find File to Upload field.

Once the file is successfully uploaded, the Find File to Upload field is replaced with a Loaded From File summary of the file’s contents, including a Channel Map Summary, Installer Menu Summary, and Setup Menu Summary.

- Double-click on each item in the Loaded From File summary at the left of the page that you would like to copy to the FTG Configuration List at the right of the page. As you move your mouse over the contents of a summary field, the field will be highlighted in blue, and  arrows at the right of the field will indicate that the data may be copied to the FTG Configuration List.
- Edit the configuration of the items in the FTG Configuration List as well as the FTG Configuration List itself, as necessary, to create a new file.

Note: While Setup Menu profiles can be included in the new FTG Configuration file (i.e., the profile[s] can be copied to the FTG Configuration List), Setup Menu profiles are not available for editing. However, on the File Manager page, you may change the Zone assignment for a Setup Menu profile, as required, for those models on which the TV Zoning feature is supported.

Note: If desired, you can click on the **UPLOAD NEW FILE** button below the list of Loaded From File items to select a different existing FTG Configuration file. If you want to add Installer Menu and/or Setup Menu profiles from more than one existing file to the new FTG Configuration file, make sure to transfer the appropriate items from the currently uploaded file to the FTG Configuration List before uploading a different file.

(Continued on next page)

Cloud Configuration Tool Overview (Cont.)

(Continued from previous page)

3. If you need to edit the FTG Channel Map from an existing file (see previous step) or create a new FTG Channel Map, click on **CHANNEL MAP** in the menu options bar at the top left of the page to access the Channel Map web page (see example on page 68), and edit/create the FTG Channel Map. Up to 600 logical channels—combined total of both RF and IP mapped channels—can be defined in the FTG Channel Map.

4. (Optional) To load default FTG Installer Menu settings by model, click on **INSTALLER MENU** in the menu options bar at the top left of the page to access the Installer Menu web page (see example on page 69), select the desired model/chassis ID and the desired Zone, and then click on the **CREATE PROFILE** button to create a new profile.

The new model profile will be added to the Installer Menu Profile List at the top right of the page, and the Installer Menu items for the selected model will now be displayed on the lower half of the page. The Summary tab shows the features that are available for configuration. Click on any Installer Menu item in the Summary tab or a category tab (User, Tuning, Audio, etc.) to view and/or edit its parameters, as required.

Note: Unless you select a different Zone assignment when you create the new profile, the default Zone 0 is assigned automatically. See Reference section, “Using the TV’s Zoning Features,” for further information on the TV Zoning feature and setting the TV Zone # in the TV(s).

5. Click on **FILE MANAGER** in the menu options bar at the top left of the page to return to the File Manager web page. The FTG Configuration List will now be populated with summaries of the FTG Channel Map, FTG Installer Menu profile(s), and, if applicable, Setup Menu profile(s) you created or added in the previous steps. Review and edit the FTG Configuration List, as necessary.

Note: If you need to edit the Channel Map or an Installer Menu profile, double-click on the desired item to access the Channel Map page or the Installer Menu page, as applicable. When you return to the File Manager page, the FTG Configuration List is automatically updated with all Channel Map and Installer Menu changes. (Installer Menu and/or Setup Menu profile Zone assignments may be changed on the File Manager page.)

Note: To remove an individual item from the FTG Configuration List, click on the **X** at the right of the applicable item. At the prompt for confirmation , either click **yes** to confirm and remove the item immediately, or click **no** to retain the item. To clear all current FTG Configuration List contents, click on the **CLEAR LIST** button at the bottom right of the FTG Configuration List.

6. Export the FTG Configuration List contents to an FTG Configuration (.tlx) file on the PC’s hard drive for later use:

- Type a brief descriptive name in the File Name field at the bottom of the FTG Configuration List (avoid using special characters, such as ?, &, @, etc.).
- Click on **EXPORT FILE**.
- In the Save As window (if applicable—see note below), select the desired location to which to export the file (you can also edit the file name here, if necessary), and click **Save**.

Note: Depending on the browser you are using and its current settings, files may automatically be saved to the “Downloads” or another designated folder on your PC. If you want to be able to select the folder in which to save the FTG Configuration file, check your browser settings.

7. Transfer the FTG Configuration (.tlx) file to a USB memory device, and proceed to “Importing a Clone File” on pages 59 to 63 to transfer the FTG Configuration file to a UT782V TV.

Cloud Configuration Tool Overview (Cont.)

File Manager Web Page Overview

The File Manager page (displayed after you select ADVANCED SETUP from the Welcome page) enables you to compile, modify, and save (export) FTG Configuration (.tlx) files. The following example provides an overview reference of the functions available on the File Manager page.

Data contained in uploaded FTG Configuration (.tlx) file. Users may choose to copy some or all of this data to the FTG Configuration List.

Data to be saved in the FTG Configuration (.tlx) file. This data may include contents transferred from an uploaded file and/or Channel Map/Installer Menu contents created or modified in the Cloud Configuration Tool.

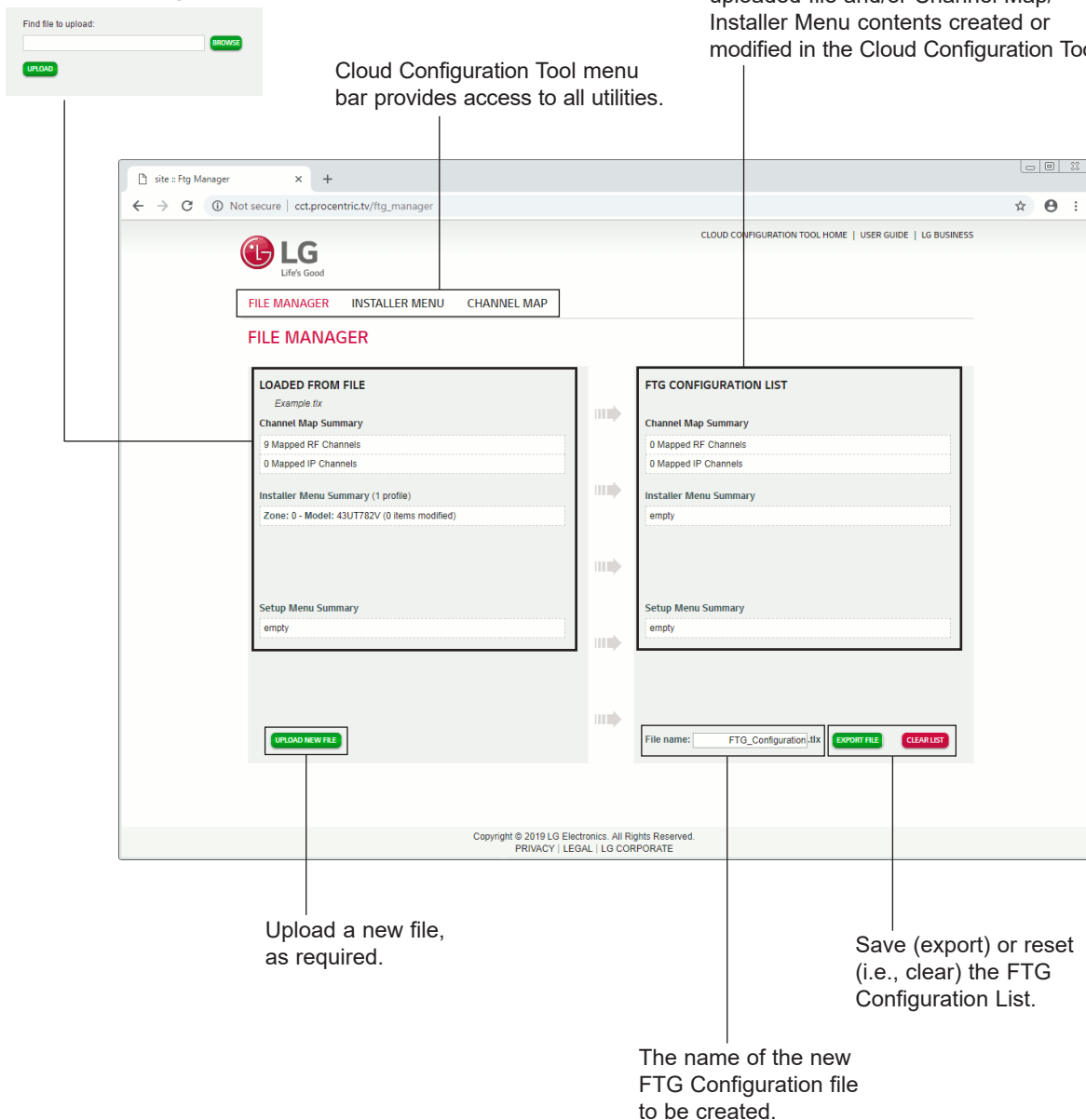

Cloud Configuration Tool Overview (Cont.)

Channel Map Web Page Overview

On the Channel Map page, you can create, view, and edit a Logical Channel Map.

Search for existing channels or clear the FTG Channel Map.

(Advanced Setup only) Cloud Configuration Tool menu bar provides access to all utilities.

Click the appropriate button to add a new RF or IP channel to the FTG Channel Map.

(Wizard Setup only) Proceed to next step.

Channel Map Search: (enter Logical or Label) OR

| Logical | Channel Logo | Label | RF IP Address | Major IP Address | Minor IP Address | PLP ID | IP Type | IP Port | Prog # | Source Address | Attribute | Restricted from Zones | Actions |
|---------|--------------|-----------|---------------|------------------|------------------|--------|---------|---------|--------|----------------|---------------|-----------------------|---------|
| 1 | CBS | CBS | 2 | 2 | 0 | | | | | | Encrypted OSD | No | |
| 2 | NBC | NBC | 20 | 20 | 5 | | | | | | Encrypted OSD | No | |
| 3 | CNN | CNN | 81 | 81 | 1 | | | | | | Encrypted OSD | No | |
| 4 | ABC | ABC | 18 | 18 | 1 | | | | | | Encrypted OSD | No | |
| 5 | PBS | PBS | 19 | 19 | 3 | | | | | | Encrypted OSD | No | |
| 6 | History | History | 86 | 86 | 2 | | | | | | Encrypted OSD | No | |
| 7 | Discovery | Discovery | 58 | 58 | 2 | | | | | | Encrypted OSD | No | |
| 91 | no logo | Video | 72 | 72 | 47 | | | | | | Encrypted OSD | No | |
| 93 | no logo | HDMI 1 | 133 | 133 | 0 | | | | | | Encrypted OSD | No | |

Click the appropriate icon to either edit an existing Logical Channel's data (see below) or remove a channel from the FTG Channel Map.

This example shows how to define an Aux input in the FTG Channel Map. See also Reference section, "TV Aux Input Configuration."

Copyright © 2023 LG Electronics. All Rights Reserved. PRIVACY | LEGAL | LG CORPORATE

Select a channel logo (select "No Logo" if applicable), and/or enter a custom channel label.

As applicable, assign the RF, Major, and Minor channel numbers and PLP ID or enter the IP Address, Type, IP Port, and Program # data for the channel.

Set Zone restriction(s) per channel. Zones you select will be listed in the Restricted from Zones column. See Reference section, "Using the TV's Zoning Features," for further information.

Enter a logical channel number.

Set channel attributes. Check/select Encrypted, OSD, or Blank Video.

After adding a new channel or editing an existing channel, save or cancel the changes.

Logical Channel Logo Label RF Major Minor PLP ID IP Address IP Type IP Port Prog # Source Address Attribute Restricted from Zones Actions

0 no logo 17 Character Limit 1 1 0 ATSC 3.0 Encrypted OSD Blank Video Zone 1 Zone 2 Zone 3 Zone 4 Zone 5 Zone 6 Zone 7 Zone 8

Cloud Configuration Tool Overview (Cont.)

Installer Menu Web Page Overview

(Advanced Setup only) Cloud Configuration Tool menu bar provides access to all utilities.

Load default Installer Menu for selected model. Assign Zone as applicable. Once you click on CREATE PROFILE, this Installer Menu profile will be listed under the Installer Menu Profile List, and Installer Menu items will be displayed on the lower half of the page.

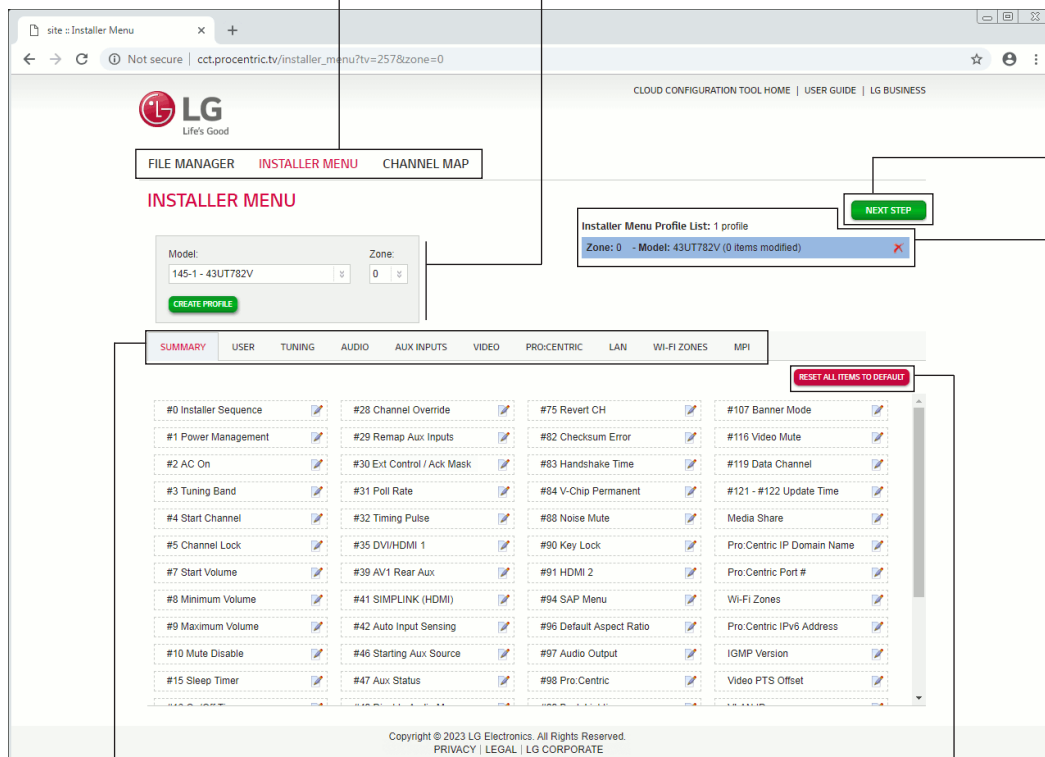

(Wizard Setup only) Proceed to next step.

Installer Menu profiles to be included in the FTG Configuration (.tlx) file. The currently active profile is highlighted.

Select tabs for categories of Installer Menu items to set up TV.

Reset default values for currently active configuration profile. A RESET button is also available within each category tab.

Note: The Pro:Centric tab enables you to set up Pro:Centric-specific parameters, the LAN tab enables you to set up a variety of LAN features, and the Wi-Fi Zones tab enables you to set up Wi-Fi Zones. Refer to the **Cloud Configuration Tool User Guide** for further information. Also, see Reference section, "Using the TV's Zoning Features," for additional information on Wi-Fi Zoning.

IP Environment Setup

The IP Environment Menu enables you to set up the network features of the TV. If you intend to create a Master TV Setup for cloning purposes (see Master TV Setup procedure on pages 54 to 56), all IP Environment settings, with the exception of wired network (Ethernet) settings, LG Connect settings, the TV name (editable in the Media Share Menu), and SoftAP settings, may be cloned.

Note: With the exception of network settings, the IP Environment settings are editable (with the Installer Remote) only if the TV is in Pass-through Mode and read-only when the TV is not in Pass-through Mode.

Accessing the IP Environment Menu

The IP Environment Menu is accessible from the First Use Wizard or from the Installer Menu. For information on accessing the IP Environment Menu from the First Use Wizard, see “First Use Wizard” on pages 18 to 19. The steps below describe how to access the IP Environment Menu from the Installer Menu.

Note: When you enter the IP Environment Menu, the Installer Menu is exited (all current settings are saved automatically upon exit). If you are also in the process of updating Installer Menu items, you may wish to set all items as needed before you access the IP Environment Menu. Otherwise, after exiting the IP Environment Menu, you will need to reaccess the Installer Menu to set additional items.

1. Use the Installer Remote to access the Installer Menu (see “Accessing the Installer Menu” on page 42 for further information).
2. Navigate to Installer Menu item 119 DATA CHANNEL, and press **2-5-3 + MENU SETTINGS** to launch the IP Environment Menu.

Use the Up/Down arrow keys on the Installer Remote to select the desired menu option and then press **OK**. Refer to the following sections for information on each of the IP Environment setup options.

When you have completed your IP Environment configuration as required, press **EXIT** or **↩** on the Installer Remote to exit the IP Environment Menu.

Network Configuration

This section describes each of the options available in the Network Menu (see example at right). Refer to the appropriate subsection(s) on the following pages.

 **Note: If you intend to use the Wi-Fi Zoning feature with cloning configuration, you must configure the wireless network connection as part of the Master TV Setup. See “Configuring a Wi-Fi Network Connection” on pages 72 to 73 for further information.**

Accessing the Network Menu

With the IP Environment Menu on display, use the arrow keys on the Installer Remote to select the **Network** menu option. Then, press **OK**.

Note: The TV’s MAC address is displayed at the top of the Network Menu screen and cannot be modified.

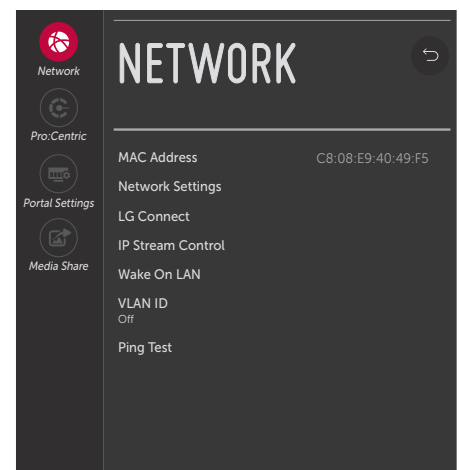

Configuring a Wired Network Connection

Note: If desired, you can configure both wired and wireless connections to the Local Area Network (LAN). However, note that a wired connection is always prioritized over a wireless connection. That is, if an Ethernet cable is connected between the network and the TV's LAN port, the TV will default to the wired connection. If the Ethernet cable is removed, the TV will then attempt to establish the wireless connection. Whenever the Ethernet cable is reconnected to the TV's LAN port, the TV will re-establish the wired connection.

1. Connect the appropriate cable between the TV and the network.
2. With the Network Menu on display, use the arrow keys on the Installer Remote to select **Network Settings**. Then, press **OK**. A Network Settings screen (see example at right), with Wired and Wi-Fi Connection setup options, will be displayed.

By default, the TV uses DHCP, and if a LAN is detected, the TV will request an IP address from the DHCP server on the network as soon as you select "Network Settings." If the TV is able to connect to the network, a "Connected to Internet" message will appear below the Wired Connection (Ethernet) field.

3. If the network is not configured for DHCP, or if you want to enable/disable IPv6, specify static IP configuration data (applicable only for IPv4), or change the network configuration from Manual to Automatic, select **Wired Connection (Ethernet)** and press **OK**.

In the Wired Connection (Ethernet) screen, you can change the IPv6 status and/or edit the IPv4 data for this TV.

4. To enable/disable IPv6, select/highlight the IPv6 field and press **OK**. Then, select **Enabled** or **Disabled** from the drop-down list of options, as applicable.
5. To edit/specify static IPv4 data or change the network configuration from Manual to Automatic, use the arrow keys on the Installer Remote to select **Edit** at the bottom of the screen and press **OK**. Then, in the Edit screen:
 - Select or de-select the "Set Automatically" checkbox, as required. A checkmark indicates that Automatic configuration is enabled.
 - To manually edit the IP data, for each data entry field: Use the arrow keys on the Installer Remote to select the field and press **OK**. You can use the number keys on the Installer Remote to direct enter numeric values or use the arrow keys to select the appropriate alphanumeric characters (as applicable) from the pop-up virtual keyboard displayed at the bottom of the screen. When you are done, select **Enter** from the virtual keyboard, and then press **OK** on the Installer Remote.

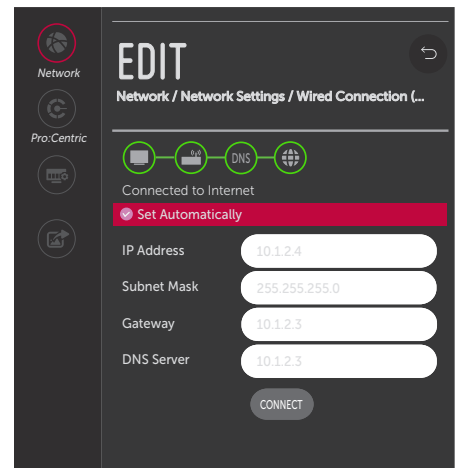
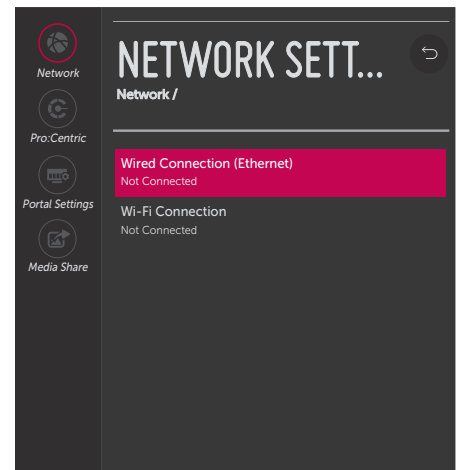

(Continued on next page)

IP Environment Setup (Cont.)

(Continued from previous page)

Note: You must use the dot “.” key from the virtual keyboard to separate each octet of an IP address.

- When all Edit fields are set as required, use the arrow keys on the Installer Remote to select **Connect** and press **OK**.

At the top of the screen, you will see a progress display that indicates status as each network element is confirmed (see example on previous page).

If the network is connected successfully, a “Connected to Internet” message will appear just below the progress display. If the network connection is not successful, the progress display will identify the network element in which the connection failed. Check your cabling and/or verify the configuration data, as necessary.

6. When you are finished, use the arrow keys on the Installer Remote to return to the IP Environment Menu, as necessary, or press ↵ to return to the previous Network Menu level(s) and/or exit the IP Environment Menu.

Configuring a Wi-Fi Network Connection

1. With the Network Menu on display, use the arrow keys on the Installer Remote to select **Network Settings**. Then, press **OK**.
2. A Network Settings screen (see example at right), with Wired and Wi-Fi Connection setup options, will be displayed. Select **Wi-Fi Connection** and press **OK**.
3. In the Wi-Fi Connection screen (see example on following page), available access points are listed in the top half of the screen, while additional menu options are listed below. Use the arrow keys on the Installer Remote to select the desired access point, or select the type of wireless connection to configure (see descriptions below). Then, press **OK**.
 - Hidden network: Direct enter the SSID—up to 32 characters—of an access point whose SSID has not been enabled for broadcast (i.e., the access point does not appear in the list of access points).
 - WPS PBC: Connect to a network via an access point that is enabled for PBC.
 - WPS PIN: Complete network/PIN verification via the access point web interface.

Make sure you have the network security password—at least eight, but no more than 32 characters—or PIN available if you are attempting to connect to a secured network.

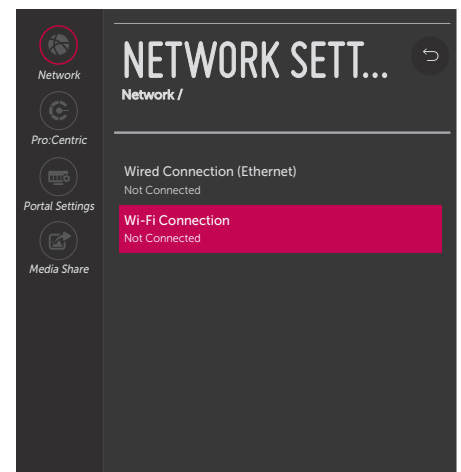

(Continued on next page)

(Continued from previous page)

4. Follow the on-screen instructions to complete the appropriate network configuration. Use the Installer Remote to navigate between fields and make entries, etc.

Note: As with a wired connection, you will have the option to enable/disable IPv6 or specify static IP configuration data for this network connection. Once the initial connection is established, you can select **Advanced Wi-Fi Settings** (initially greyed out) at the bottom of the Wi-Fi Connection screen to view the IP configuration data. In the Advanced screen, select **Edit** and press **OK**, and then change the IPv6 status and/or modify the IP data, as required. See steps 4 and 5 of the wired connection procedure above for further information on the Edit screen fields.

5. When you are finished, use the arrow keys on the Installer Remote to return to the IP Environment Menu, as necessary, or press **↶** to return to the previous Network Menu level(s) and/or exit the IP Environment Menu.

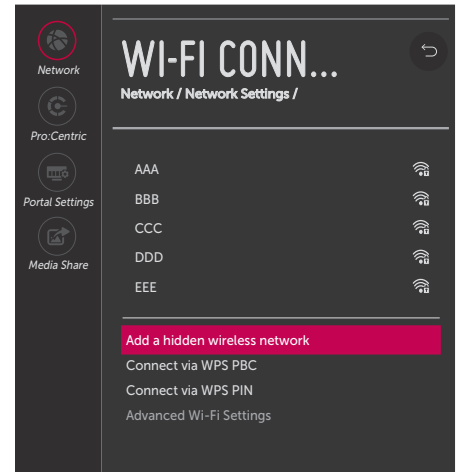

LG Connect

LG Connect allows end users to use LG webOS Connect apps to pair the TV with a mobile device, which can then be used to access and control TV features (i.e., the device may be used as a mobile remote).

LG Connect requires that both the TV and the mobile device be on the same Wi-Fi network. See “Configuring a Wi-Fi Network Connection” above for information on configuring the wireless network connection. This menu enables you to turn LG Connect either on (default) or off. It also allows you to delete all existing stored device pairings.

1. With the Network Menu on display, use the arrow keys on the Installer Remote to select **LG Connect**. Then, press **OK**.
2. Select/highlight the On/Off toggle button at the top right of the LG Connect screen, and press **OK** on the Installer Remote to turn LG Connect on or off.
3. If you wish to delete all stored device pairings, turn on LG Connect as described in the previous step (if it is not on already), select/highlight the **REVOKE PAIRING** button (only accessible when LG Connect is turned on), and press **OK** on the Installer Remote. At the prompt for confirmation, either select **YES** and press **OK** to delete the list of paired devices, or select **NO** and press **OK** to return to the LG Connect screen without deleting stored pairings.
4. When you are finished, use the arrow keys on the Installer Remote to return to the IP Environment Menu, as necessary, or press **↶** to return to the Network Menu and/or exit the IP Environment Menu.

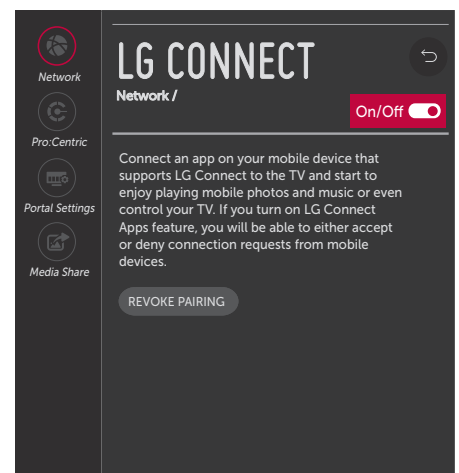

IP Environment Setup (Cont.)

IP Stream Control

If necessary, due to an audio and/or video stream delay, IP Stream Control options enable you to compensate for synchronization irregularities by allowing audio PTS and video PTS offset modifications. This menu also enables you to specify the IGMP version (2 or 3). Note that any modifications to these settings should be performed by qualified personnel only.

1. With the Network Menu on display, use the arrow keys on the Installer Remote to select **IP Stream Control**. Then, press **OK**.
2. In the IP Stream Control screen, use the Up/Down arrow keys on the Installer Remote to select/highlight the appropriate field and press **OK**.
 - To modify an offset value: use the Left/Right arrow keys to select the appropriate value for the selected field. Offset values represent offset time in milliseconds (ms) and can be adjusted from -500 ms to +500 ms in 10 ms increments.
 - To modify the IGMP version: use the Up/Down arrow keys to select the appropriate version number from the drop-down list of options, and then, press **OK**.
3. When you are finished, use the arrow keys on the Installer Remote to return to the IP Environment Menu, as necessary, or press **↵** to return to the Network Menu and/or exit the IP Environment Menu.

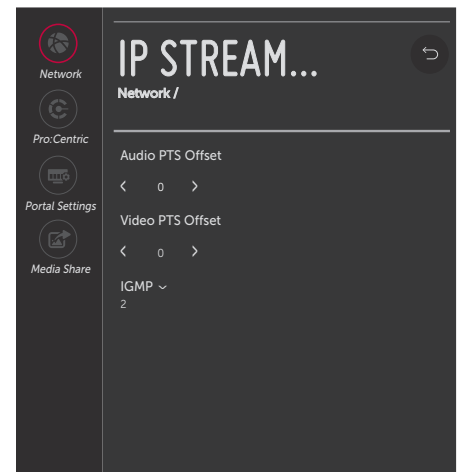

Wake On LAN Setup

The Wake On LAN feature enables the TV to receive software updates and/or be powered ON upon receipt of Magic Packet data via the wired LAN. To facilitate use of this feature, note that the appropriate wired connection must be made. This menu option enables you to specify Wake On LAN parameters.

1. With the Network Menu on display, use the arrow keys on the Installer Remote to select **Wake On LAN**. Then, press **OK**.
2. In the Wake On LAN screen, use the Up/Down arrow keys on the Installer Remote to select/highlight the WOL (Magic Packet) field (if it is not already selected) and press **OK**. Then, use the arrow keys to select the desired setting—Disabled, Update, or Power On—from the drop-down list of options.
3. When you are finished, use the arrow keys on the Installer Remote to return to the IP Environment Menu, as necessary, or press **↵** to return to the Network Menu and/or exit the IP Environment Menu.

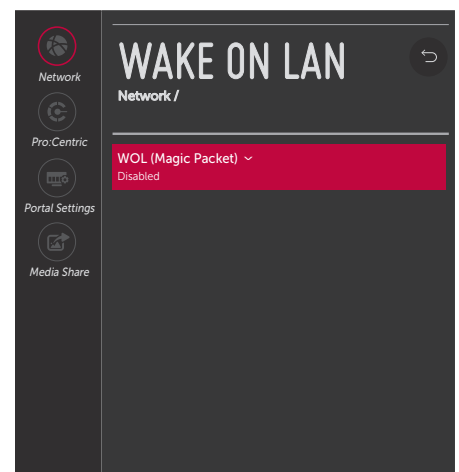

VLAN ID Setup

The VLAN ID option enables you to specify a VLAN ID for the LAN and Aux LAN ports.

1. With the Network Menu on display, use the arrow keys on the Installer Remote to select **VLAN ID**. Then, press **OK**.
2. When you initially access the VLAN ID screen, the On/Off toggle button at the top right of the screen is selected/highlighted by default. Press **OK** on the Installer Remote to turn on VLAN ID.
3. Use the Up/Down arrow keys on the Installer Remote to select/highlight the LAN ID field and press **OK**. You can then use the number keys on the Installer Remote to direct enter the LAN ID, or you can use the arrow keys to select the appropriate number(s) from the pop-up virtual keyboard displayed at the bottom of the screen. When you are done, select **Enter** from the virtual keyboard, and then press **OK** on the Installer Remote.

Repeat this step for the Aux LAN ID field.

4. When you are finished, use the arrow keys on the Installer Remote to return to the IP Environment Menu, as necessary, or press **↵** to return to the Network Menu and/or exit the IP Environment Menu.

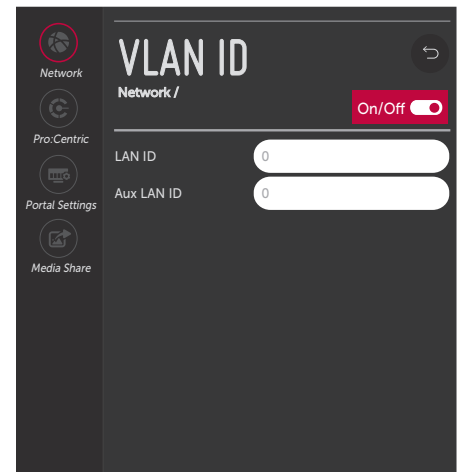

Ping Test

The Ping Test option enables you to ping an IPv4 or IPv6 network address or URL.

1. With the Network Menu on display, use the arrow keys on the Installer Remote to select **Ping Test**. Then, press **OK**.
2. In the ENTER THE NETWORK ADDRESS TO PING pop-up window at the bottom of the screen, use the arrow keys on the Installer Remote to select the desired Type option—IPv4 or IPv6 (i.e., IP Address) or URL.
3. To enter the IP address or URL data, select each data entry field and press **OK**. You can use the number keys on the Installer Remote to direct enter numeric values or use the arrow keys to select the appropriate alphanumeric values (as applicable) from the pop-up virtual keyboard displayed at the bottom of the screen. When you are done, select **Enter** from the virtual keyboard, and then press **OK** on the Installer Remote.
4. When you are ready, select **BEGIN TEST**, and then press **OK** on the Installer Remote.

(Continued on next page)

IP Environment Setup (Cont.)

(Continued from previous page)

The network address will be pinged 10 times and then a summary of the ping statistics will be displayed, for example:

PING TEST RESULT

Ping statistics for [xxx.xxx.xxx.xxx]

Packets : Sent = 10, Received = 10, Lost = 0 (0% loss)

Approximate round trip times in milliseconds

Minimum = 0.462 ms, Maximum = 5.43 ms, Average = 1.784 ms

5. Select **OK** in the pop-up window, and then press **OK** on the Installer Remote to close the pop-up window when you are finished.

Pro:Centric Setup

Pro:Centric options enable you to configure the TV with the appropriate settings to connect to the Pro:Centric server. Use the Up/Down arrow keys on the Installer Remote to navigate between fields.

1. With the IP Environment Menu on display, use the arrow keys on the Installer Remote to select the **Pro:Centric** menu option. Then, press **OK**.
2. Select/highlight the **Media Type** field and press **OK** on the Installer Remote to display the drop-down list of options. Then, use the Up/Down arrow keys to select either **RF** or **IP**, as applicable.

Note: By default, the Pro:Centric Menu initially shows RF configuration fields. When “IP” is selected as the Media Type, Server Address, IP Type, IP Address, and Port Number fields appear on the screen (in place of the Data Channel field).

Note: If the Media Type has already been set in the EZ-Manager Wizard, the specified value will be reflected in this field.

3. Refer to the appropriate subsection(s) below to configure the TV’s Pro:Centric settings to match those of the Pro:Centric server.

While the Pro:Centric application itself is an additional feature (see step 4), the appropriate Pro:Centric server configuration must be completed to enable TV E-Z Installation (boot logo, configuration, and software) data downloads and, if configured, the Pro:Centric application download.

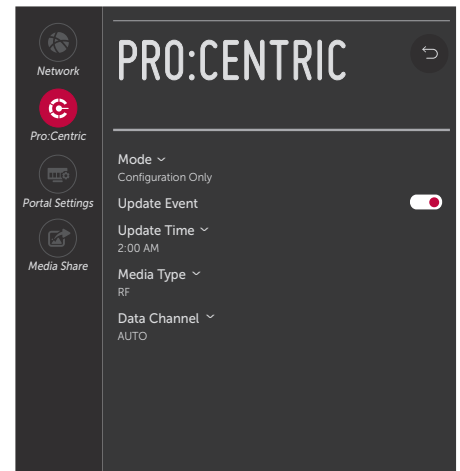

(Continued on next page)

(Continued from previous page)

RF Configuration

For TVs in Pass-through Mode or FTG Mode, if the Data Channel is left at its default value (AUTO), the TV's Data Channel Auto Search feature will be enabled. See Installer Menu item 119 DATA CHANNEL description on page 52 for further information.

- To change the Data Channel setting, select/highlight the **Data Channel** field and press **OK** on the Installer Remote. Then, use the Up/Down arrow keys to select either **MANUAL** or **AUTO** from the drop-down list of options.
- When the Data Channel field is set to "MANUAL," a data entry field is available on the screen, and you can specify the RF channel number that will be used by the Pro:Centric server as its data channel. The Data Channel value can be set from 0 (disabled) to 135.*

Use the arrow keys on the Installer Remote to select the Data Channel data entry field and press **OK**. You can then use the number keys on the Installer Remote to direct enter the Data Channel, or you can use the arrow keys to select the appropriate number(s) from the pop-up virtual keyboard displayed at the bottom of the screen. When you are done, select **Enter** from the virtual keyboard, and then press **OK** on the Installer Remote.

Note: If the Data Channel has already been set in the Installer Menu (item 119) or in the Solution Settings / EZ-Manager Wizard, the specified channel will appear in the Data Channel data entry field. If you change the Data Channel in this menu, Installer Menu item 119 will now show the value you entered here.

IP Configuration

Note: If the server IP address and port number or domain name have already been set in the Solution Settings / EZ-Manager Wizard, the specified data will be reflected in the fields displayed.

Note: Setting the Media Type to "IP" automatically sets item 119 DATA CHANNEL in the Installer Menu to 253. You cannot alter this setting unless you revert Media Type to "RF." Also, it is not possible to direct enter "253" in the Installer Menu.

- a) The Server Address field provides the option to specify the domain name of the Pro:Centric server instead of the server's IP address. Select/highlight the **Server Address** field and press **OK** on the Installer Remote. Then, use the Up/Down arrow keys to select either **IP Address** or **Domain Name** from the drop-down list of options for defining the server.
- b) Depending on your selection in the previous step, either:
 - Select the appropriate IP type (either IPv4 or IPv6) in the IP Type field, and then enter the Pro:Centric server IP address in the IP Address field. The IP address must match the IPv4 or IPv6 (as applicable) address that is set in the Pro:Centric server.

(Continued on next page)

* PCS150R and later Pro:Centric servers do not support HRC or IRC cable channel frequencies.

IP Environment Setup (Cont.)

(Continued from previous page)

- Enter the Pro:Centric server domain name—up to 63 characters (no spaces allowed)—in the Domain Name field. Note that in order for the domain name to be resolved to an IP address, there must be a DNS entry for the domain name.

For each data entry field: Use the arrow keys to select the field and press **OK**. Then, you can either use the number keys on the Installer Remote to direct enter data values, or you can use the arrow keys to select the appropriate number(s)/alphanumeric character(s) from the pop-up virtual keyboard displayed at the bottom of the screen. When you are done, select **Enter** from the virtual keyboard, and then press **OK** on the Installer Remote.

- c) Enter the Pro:Centric server port number in the Port Number field. The port number must match the port number that is set in the Pro:Centric server.
4. Select/highlight the **Mode** field and press **OK** on the Installer Remote to display the drop-down list of options. Then, use the Up/Down arrow keys to select the appropriate Pro:Centric Application Mode setting—**Configuration Only**, **GEM** (Java), or **HTML**. If the Pro:Centric Application Mode is set to “Configuration Only,” Pro:Centric application data will not be downloaded.
Note: If the mode has already been set in the Installer Menu (item 098 PRO:CENTRIC) or in the Solution Settings / EZ-Manager Wizard, the specified mode will be reflected in this field. If you change the mode in this menu, Installer Menu item 098 will now reflect the value you selected here.
 5. Select/specify the appropriate Update Event setting(s), as required. Based on Update Time settings, the Wake For Update feature wakes the TV once daily to check for, and if applicable, download updates from the Pro:Centric server. See Installer Menu item 121 UPDATE TIME HR description on page 52 for additional information on Wake For Update functionality.
 - Select/highlight the **Update Event** field and press **OK** on the Installer Remote to toggle the setting as required. When Update Event is enabled, an Update Time field is displayed on the screen.
 - If Update Event is enabled, set the Update Time as required. Use the arrow keys on the Installer Remote to select/highlight the Update Time field, and then press **OK**. Hour, Minute, and Meridiem fields will be displayed. Select each field in turn and specify the appropriate Wake For Update time, as desired. Note that the Update Time set in this menu is based on a 12-hour clock. Ensure the meridiem (AM/PM) specification is set accordingly.
 6. When you are finished, use the arrow keys on the Installer Remote to return to the IP Environment Menu, as necessary, or press ↵ to exit the IP Environment Menu.

Portal Settings

The Portal Settings Menu enables you to set up a customized local portal for this TV. It also allows you to select which of the pre-loaded application icons to display in the TV's Smart Launcher. Refer to the appropriate subsection below.

Portal Options

Portal setup options in the Portal Menu are independent of the Pro:Centric portal. If you intend to load a Pro:Centric application on the TV(s) at the site, use the appropriate Pro:Centric Admin Client to configure the portal features.

1. With the IP Environment Menu on display, use the arrow keys on the Installer Remote to select the **Portal Settings** menu option. Then, press **OK**.
2. Select/highlight the **Portal Mode** field and press **OK** on the Installer Remote to display the drop-down list of options. Then, use the Up/Down arrow keys to select the applicable setting—Default Portal, Customizable Portal, or None.
Note: If the Portal Mode has already been set in the Basic Settings Wizard, the specified value will be reflected in this field.
Note: The default value in this field is “Default Portal,” which enables the TV's standard Smart Launcher. See also “Pre-loaded Applications” below.
3. Select/highlight the **Auto Start** field and press **OK** on the Installer Remote to display the drop-down list of options. Then, use the Up/Down arrow keys to select the applicable setting—Off or Portal Mode. This specifies whether the portal should be displayed each time the TV is turned ON (as opposed to only being displayed when the user presses PORTAL on the remote).
Note: If the Auto Start status has already been set in the Basic Settings Wizard, the specified value will be reflected in this field.
4. Use the Website Shortcut, Input Shortcut, Hotel Directory, Portal Editor, and Portal Manager options to create and/or modify the customized portal content, as applicable. You may add up to five website shortcuts and up to seven hotel directories. Follow on-screen instructions to complete the setup.
5. When you are finished in the Portal Settings Menu, use the arrow keys on the Installer Remote to return to the IP Environment Menu, as necessary, or press **↵** to exit the IP Environment Menu.

Note: For further information on the portal settings and options, please contact your LG representative.

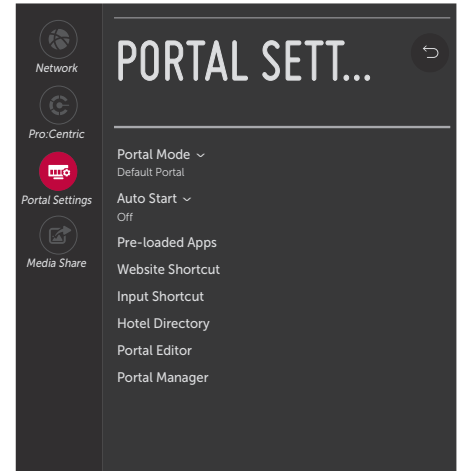

IP Environment Setup (Cont.)

Pre-loaded Applications

This option allows you to select which of the pre-loaded application icons to display/make available in the TV's Smart Launcher, which appears along the bottom of the screen in the TV's default Portal Mode.

When the Pro:Centric application is disabled, the Smart Launcher is available to end users via the PORTAL key on the remote control. The Smart Launcher is also available to end users via the SMART key on the remote control.

1. With the IP Environment Menu on display, use the arrow keys on the Installer Remote to select the **Portal Settings** menu option. Then, press **OK**.
2. Make sure the Portal Mode is set to "Default Portal." If necessary, select/highlight the **Portal Mode** field and press **OK** on the Installer Remote to display the drop-down list of options. Then, use the Up/Down arrow keys to select **Default Portal**.
3. Use the arrow keys on the Installer Remote to select **Pre-loaded Apps**. Then, press **OK**.
4. In the Pre-loaded Apps Menu (see example at right), a list of available application options is displayed. Use the Up/Down arrow keys to highlight each application you wish to select or de-select, and press **OK** on the Installer Remote. When an application is selected, the radio button at the left of the application name is red.

Note: Though not included in the application list on this screen, Screen Share and SoftAP (as Wi-Fi Service) applications are available in the Smart Launcher once they are enabled in the Media Share Menu. See "Media Share Setup" below.

Note: Make sure to select any application(s) that may be used in conjunction with the DIAL feature, if applicable. Also, if desired, with the Web Browser application, you may specify the default home page.

5. When you are finished in the Portal Settings Menu, use the arrow keys on the Installer Remote to return to the IP Environment Menu, as necessary, or press ↵ to exit the IP Environment Menu.

Note: While pre-loaded application selections are clonable, it is not possible to edit pre-loaded application selections in the Cloud Configuration Tool. Thus, if a TV has already been configured for FTG Mode and you would like to add or remove applications, you will need to import a new ".tlx" file with the appropriate model profile. That is, you will need to use a Master TV of the same model to create and export a ".tlx" file with the desired pre-loaded application selections (along with any other applicable Installer Menu settings), which can be transferred (imported) to the Target TV.

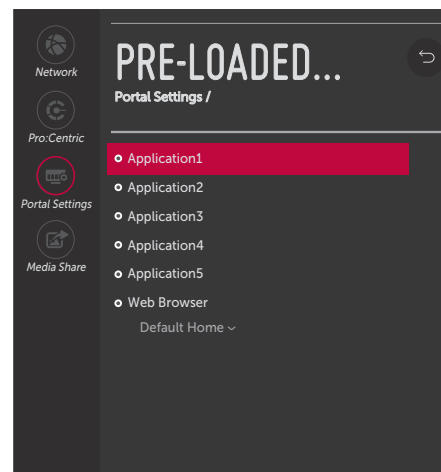

Media Share Setup

The Media Share Menu allows you to enable the following Media Share features on this TV:

- LG Smart Share®: Allows end users to use the TV to access and view media files (photos, videos, music, etc.) shared by DLNA Certified® devices connected to the same LAN as the TV.
- Screen Share: Enables screen sharing with a Miracast® or Wireless Display (WiDi) capable device (e.g., a laptop with Intel® hardware).
- Media Renderer: Enables the TV to act as a media renderer to receive content from DLNA Certified devices on the same network.
- DIAL (Discovery and Launch): Allows end users to play selected application media on the TV from a device with DIAL capability. The device may be used to cast any application for which a TV-compatible application has been created/selected for inclusion in the Pre-loaded Apps Menu (e.g., YouTube—see also “Pre-loaded Applications” on page 80). Note that the device must be connected to the same network as the TV.
- SoftAP: Enables the TV to function as a wireless access point for up to 10 devices. Note that a wired network connection **MUST** be established in order for guests to use SoftAP.
- Beacon: Enables the TV to function as either an iBeacon™ or Eddystone™ beacon device for Bluetooth broadcasting.

Note: See also Reference section, “Using Media Share Features,” for additional information on these features.

1. With the IP Environment Menu on display, use the arrow keys on the Installer Remote to select the **Media Share** menu option. Then, press **OK**.
2. Smart Share, Screen Share, Media Renderer, and DIAL features may be enabled or disabled as follows: Use the Up/Down arrow keys on the Installer Remote to select/highlight the desired feature, and then press **OK** on the Installer Remote to toggle the setting as required.
3. If you would like to enable SoftAP, complete the SoftAP access configuration as follows:
 - Select/highlight **SoftAP** and press **OK** on the Installer Remote.
 - Select/highlight the Off/On toggle button at the top right of the SoftAP screen (see example on following page), and press **OK** on the Installer Remote to turn on SoftAP.

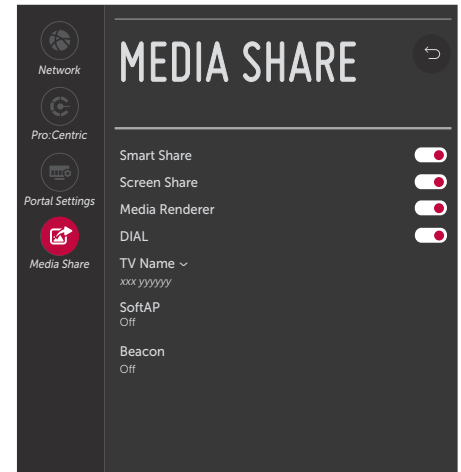

(Continued on next page)

IP Environment Setup (Cont.)

(Continued from previous page)

- Select/highlight the **Mode** field and press **OK** on the Installer Remote to display the drop-down list of options. Then, use the Up/Down arrow keys to select the applicable SoftAP Mode—either NAT (default) or Bridge.

Note: NAT Mode provides PSK security and allows private addresses to be assigned to connected devices. Bridge Mode provides PSK, EAP, or Open security and forwards DHCP packets to use the router's DHCP functionality.

- (Bridge Mode only) Select/highlight the **Security Type** field, and press **OK** on the Installer Remote to display the drop-down list of options. Then, use the Up/Down arrow keys to select the appropriate option—PSK, Open, or EAP.

Note: Depending on your Security Type selection, additional fields will be displayed, for example VLAN ID for PSK and Open security and Radius Server IP, Radius Server Port, and Radius Server Key for (802.1X) EAP security. Direct enter the appropriate value(s), as required.

- (NAT Mode or Bridge Mode with PSK security) To enable use of a randomly generated security key for SoftAP access, toggle the Use Default field so that the default security key is enabled (the Security Key field will subsequently be grayed out and the random security key will be displayed).
 - (NAT Mode or Bridge Mode with PSK security) To specify your own security key for SoftAP access, toggle the Use Default field so that the default security key is disabled. Then, select the **Security Key** field and press **OK**. In the data entry field, you can use the number keys on the Installer Remote to direct enter a numeric security key, or you can use the arrow keys to select the appropriate alphanumeric characters—at least eight, but no more than 64—from the pop-up virtual keyboard displayed at the bottom of the screen. Note that the security key may not contain any special characters (:, /, \, @, etc.). When you are done, select **Enter** from the virtual keyboard, and then press **OK** on the Installer Remote.
 - Select the appropriate values in the Wi-Fi Signal Strength and Wi-Fi Channel fields, as required.
4. If you would like to enable Beacon, complete the Beacon access configuration as follows:

Note: For iBeacon, you will need to enter the beacon's UUID, Major, and Minor parameters. For Eddystone, you will need to enter the beacon's URL parameters. You should have the pertinent information available before you continue.

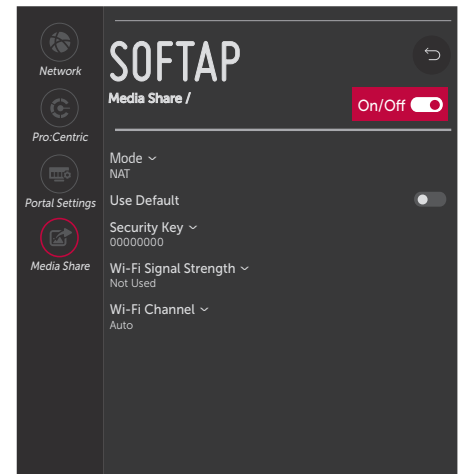

Note: NAT and Bridge Mode options are applicable with CPU v3.09.80 and later.

(Continued on next page)

(Continued from previous page)

- Select/highlight **Beacon** and press **OK** on the Installer Remote.
 - When you initially access the Beacon screen (see example at right), the On/Off toggle button at the top right of the screen is selected/highlighted by default. Press **OK** on the Installer Remote to turn on Beacon.
 - Select/highlight the **Type** field and press **OK** on the Installer Remote to display the drop-down list of options. Then, use the Up/Down arrow keys to select the applicable Beacon type—either iBeacon or Eddystone.
 - Select each data entry field in turn, and provide the appropriate information. In the data entry fields, you can use the number keys on the Installer Remote to direct enter numbers, or you can use the arrow keys to select the appropriate alphanumeric characters from the pop-up virtual keyboard displayed at the bottom of the screen. When you are done, select **Enter** from the virtual keyboard, and then press **OK** on the Installer Remote.
 - When you have entered all the beacon identification data, select the **OK** button at the bottom of the menu, and then press **OK** on the Installer Remote.
 - At the prompt for broadcast confirmation, select either **Yes** to broadcast the Beacon or **No** if you do not want to broadcast the Beacon.
5. If desired, you can specify a name for this TV so that it is easy to identify and differentiate from other TVs for which sharing has been/ will be enabled.

Note: By default, the TV name is the TV's serial number + model name. However, if a room number is specified in the Solution Settings / EZ-Manager Wizard or in the General Menu / Room Info screen, the TV name is changed to the room number.

To edit the TV name, use the Up/Down arrow keys to select the **TV Name** field, and then press **OK**. You can then use the number keys on the Installer Remote to direct enter a numeric TV name, or you can use the arrow keys to select the appropriate alphanumeric character(s) from the pop-up virtual keyboard at the bottom of the screen. When you are done, select **Enter** from the virtual keyboard, and then press **OK** on the Installer Remote.

6. When you are finished, use the arrow keys on the Installer Remote to return to the IP Environment Menu, as necessary, or press ↵ to exit the IP Environment Menu.

Note: While Smart Share, Screen Share, Media Renderer, DIAL, and Beacon settings are clonable, SoftAP settings, as well as the TV name cannot be cloned.

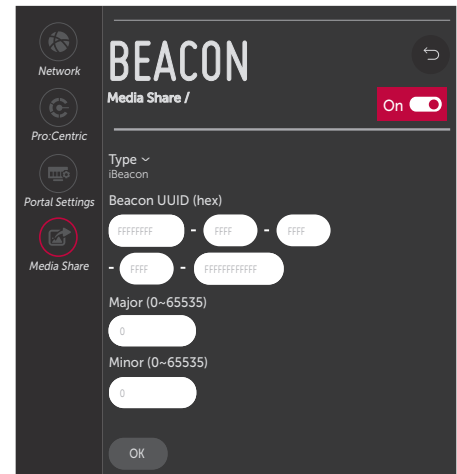

Reference: Updating TV/PTC Software using a USB Memory Device

This section describes how to update TV (CPU) and/or PTC software using the TV Manager “Update TV Software” and/or “Update PTC Software” option(s), respectively, though you may also use the Ez Download utility to update software, if desired. See “Ez Download Utility” on pages 37 to 41 for further information.

Before You Begin

- Software update files must be stored in a folder named “LG_DTV” in the root directory of the USB memory device.
- Ensure the USB device has been formatted with FAT format.

Update the TV/PTC Software

Note: You can check the TV/PTC software versions by accessing the Installer Menu with the Installer Remote. See “Accessing the Installer Menu” on page 42 for further information. PTC and CPU versions are displayed in the Installer Menu footer.

Note for TV CPU Software Update only: If the TV detects a software file on the USB device, it will automatically display an Update TV Software screen, and if the file contains a later version of software than is currently running on the TV, you can start the software update from this screen (select **UPDATE** and press **OK**). Otherwise, you can exit the screen (select **CANCEL** and press **OK**), and access the TV Manager as described below.

1. Turn ON the TV, and then insert the USB memory device into either of the USB ports on the TV.
2. Press **MENU SETTINGS** on the Installer Remote to display the TV setup menus (TV is in Pass-through Mode) or the Function Menu (TV is not in Pass-through Mode).
3. (TV in Pass-through Mode only) From the Quick Settings Menu displayed at the left of the screen, select the **All Settings**  menu icon and press **OK** to access the advanced TV setup menus.
4. Use the arrow navigation keys to select/highlight either the **General** menu icon from the TV setup menus or the **Safety** menu icon from the Function Menu. Then, press the number “7” key a total of seven times to access the TV Manager.

Note: Ez Download is always selected by default when you initially access the TV Manager. Also note that Diagnostics is for service use only.

5. If more than one USB memory device is currently connected to the TV, be sure to select the USB device that contains the applicable software file. If necessary, use the arrow keys on the Installer Remote to select/highlight the **USB DEVICE** button in the top right corner of the screen and press **OK**. Then, use the Up/Down arrow keys to select the appropriate USB device from the pop-up list of USB devices.

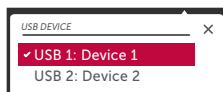

(Continued on next page)

Reference: Updating TV/PTC Software using a USB Memory Device (Cont.)

(Continued from previous page)

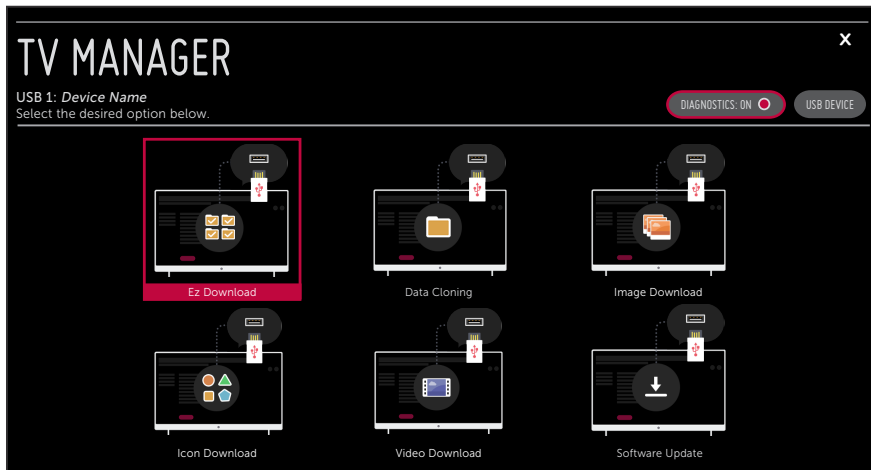

6. Use the arrow keys to select **Software Update**, and then press **OK**.
7. Use the Up/Down arrow keys to select **Update TV Software** or **Update PTC Software**, as applicable, and press **OK**.

Depending on your selection, a list of either TV or PTC software files stored in the LG_DTV folder on the USB memory device will be displayed on the screen. Above the listing of files, you can also see the current version of TV or PTC software. The following example illustrates an Update TV Software screen.

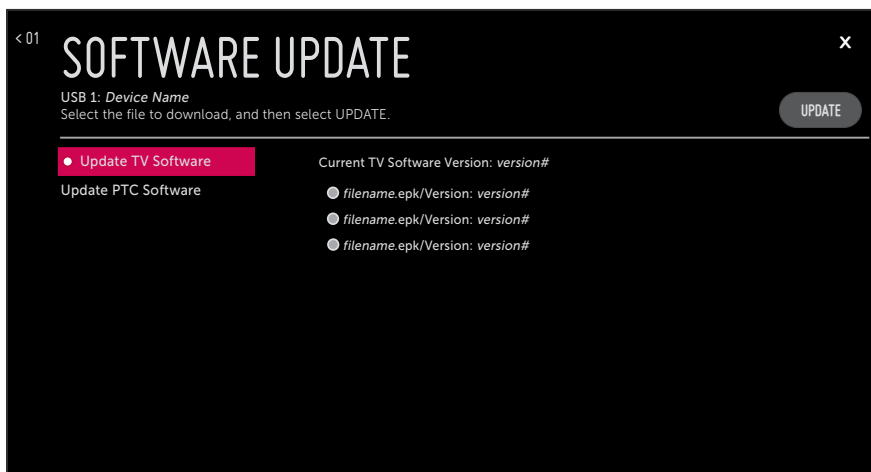

8. Use the arrow keys to select/highlight the update file to download, and then press **OK**.
9. When you are ready to download the update, select **UPDATE** on the screen, and then press **OK** on the Installer Remote.

Software update progress will be displayed on the screen. Do NOT remove the USB device until the software update is complete. When the software update is complete, a "Software Update is completed" pop-up message will briefly be displayed on the screen, and then, the TV will reboot.

Reference: Downloading Images or Icons using a USB Memory Device

This section describes how to download the image types listed below using the TV Manager “Image Download” or “Icon Download” options, though you may also use the Ez Download utility to download the image(s), if desired. See “Ez Download Utility” on pages 37 to 41 for further information.

- A boot logo image, also known as a “splash screen,” is briefly displayed when the TV is turned ON from its standby (OFF) state.
Note: When Installer Menu item 002 AC ON is set to 2, 3, 18, or 19 for Instant ON, a boot logo image is not displayed.
- Background images are intended for use with audio-only channels and applications, such as the Bluetooth Sound Sync feature or the Clock application, that by default have static backgrounds. Guests may choose to display a slideshow on the screen while audio is playing. Up to 12 images may be selected.
- Hotel Directory images are intended for use with a local customized portal. Up to 12 images may be selected for up to six hotel directories.
- The Hotel Icon on Portal icon image is used for local customized portal branding. One icon image may be selected.
- Website Shortcuts are icon images. One icon image may be selected for up to five website directories.

Boot Logo Image File Guidelines

- File formats supported: Baseline or progressive JPEG, JPG, or 24-bit (RGB 8x8x8) BMP.
- A JPEG or JPG image should be no larger than 6 MB.
- A BMP image should be no larger than 5.93 MB.
- The maximum resolution allowed for the boot logo image is 1920 x 1080 pixels.
- Avoid using special characters, such as ?, &, @, etc., in the image filename.

Background and Hotel Directory Image File Guidelines

- File formats supported: Baseline or progressive JPEG, JPG, or PNG.
- Up to 12 image files (no more than 10 MB total) may be selected for background images and/or for hotel directories.
- The maximum resolution allowed for these images is 3840 x 2160 pixels.
- Avoid using special characters, such as ?, &, @, etc., in image filenames.

Icon Image File Guidelines

- File formats supported: Baseline or progressive JPEG or PNG.
- An icon image should be no larger than 10 MB.
- The maximum resolution allowed for these images is 3840 x 2160 pixels.
- Avoid using special characters, such as ?, &, @, etc., in image filenames.

Reference: Downloading Images or Icons using a USB Memory Device (Cont.)

Before You Begin

- The image file(s) must be stored in a folder named “LG_DTV” in the root directory of the USB memory device.
- Ensure the USB device has been formatted with FAT format.

Download the Image(s)

1. Turn ON the TV, and then insert the USB memory device into either of the USB ports on the TV.
2. Press **MENU SETTINGS** on the Installer Remote to display the TV setup menus (TV is in Pass-through Mode) or the Function Menu (TV is not in Pass-through Mode).
3. (TV in Pass-through Mode only) From the Quick Settings Menu displayed at the left of the screen, select the **All Settings**  menu icon and press **OK** to access the advanced TV setup menus.
4. Use the arrow navigation keys to select/highlight either the **General** menu icon from the TV setup menus or the **Safety** menu icon from the Function Menu. Then, press the number “7” key a total of seven times to access the TV Manager.

Note: Ez Download is always selected by default when you initially access the TV Manager. Also note that Diagnostics is for service use only.

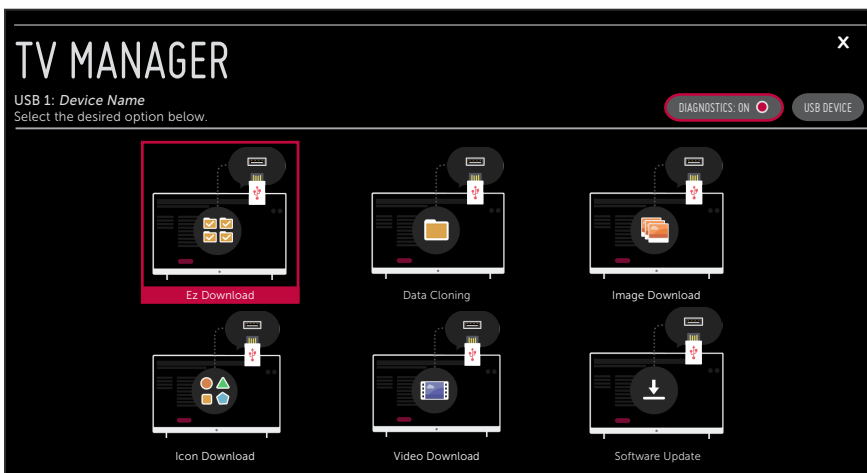

5. If more than one USB memory device is currently connected to the TV, be sure to select the USB device that contains the applicable image file(s). If necessary, use the arrow keys on the Installer Remote to select/highlight the **USB DEVICE** button in the top right corner of the screen and press **OK**. Then, use the Up/Down arrow keys to select the appropriate USB device from the pop-up list of USB devices.

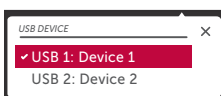

(Continued on next page)

Reference: Downloading Images or Icons using a USB Memory Device (Cont.)

(Continued from previous page)

6. Use the arrow keys to select **Image Download** or **Icon Download**, as applicable, and then press **OK**.

Depending on your selection in the previous step, either the Image Download or Icon Download screen will be displayed. The following example illustrates an Image Download screen.

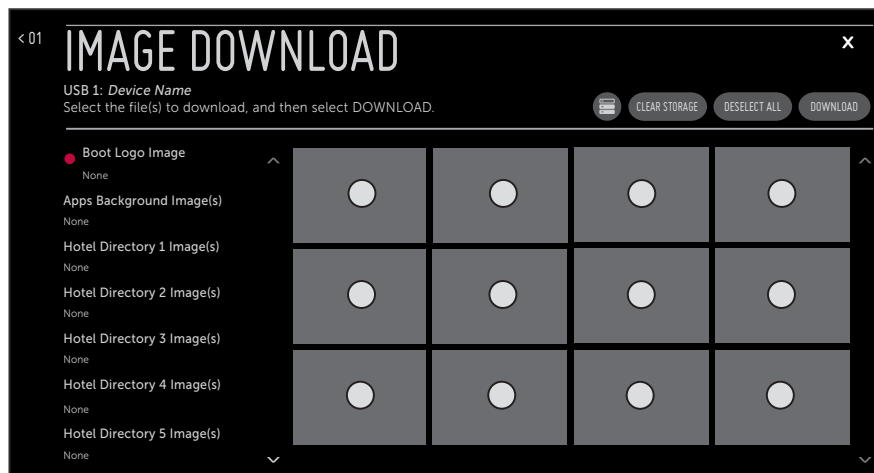

Note: You can select the  (STORAGE) button at the top of the screen to check the amount of storage available for and currently in use by media (image, icon, and video) files. Storage data will be displayed in a pop-up window. When you are finished, select **OK** to close the pop-up window. If you would like to clear all of the image or icon (depending on your selection in step 6) files currently in storage, select the **CLEAR STORAGE** button. Then, in the confirmation pop-up window, select **YES** to clear the files, or select **NO** to return to the Image Download or Icon Download screen, as applicable, without clearing the files.

7. Use the Up/Down arrow keys to select the appropriate option from the list of file types at the left of the screen, and then press **OK**.
8. In the image area at the right of the screen, use the arrow keys to select/highlight the image file(s) to download. Press **OK** to select a file (a checkmark  identifies a selected file). See also image guidelines at the beginning of this section.
9. When you are ready to download the image file(s), select **DOWNLOAD** on the screen, and then press **OK** on the Installer Remote.

Download progress will be displayed on the screen. Do NOT remove the USB device until the image download(s) is/are complete. When the download process is complete, an “Image Download is completed” or “Icon Download is completed” message will be displayed on the screen (in accordance with your selection in step 6), and a “DONE” button will be displayed/activated at the top right of the screen.

10. Check the download status—at the left of the screen—for each image to make sure the download was successful, and then press **OK** on the Installer Remote to select **DONE**.

When you select “DONE,” the Image Download or Icon Download screen (depending on your selection in step 6) will be redisplayed, and you can download additional images and/or perform other TV Manager functions, as required.

Reference: Downloading a Hotel Video using a USB Memory Device

This section describes how to download a hotel video using the TV Manager “Video Download” option, though you may also use the Ez Download utility to download the video, if desired. See “Ez Download Utility” on pages 37 to 41 for further information.

One hotel video may be selected for a local customized portal.

Video File Guidelines

- File formats supported: DIVX, AVI, MKV, MP4, 3GP, 3G2, TS, TP, TRP, MPG, MPEG, VOB, VRO, ASF, WMV, MOV, DAT, F4V, FLV, TTS, ASX, M4V, K3G, M2TS, MPE, MTS, WEBM, LGE, LG2, LGV, MZ.
- The video size is only restricted by the TV’s storage capacity. You be will able to check the amount of space available from the Video Download screen, as described in the procedure below.
- Avoid using special characters, such as ?, &, @, etc., in the video filename.

Before You Begin

- The video file must be stored in a folder named “LG_DTV” in the root directory of the USB memory device.
- Ensure the USB device has been formatted with FAT format.

Download the Video

1. Turn ON the TV, and then insert the USB memory device into either of the USB ports on the TV.
2. Press **MENU SETTINGS** on the Installer Remote to display the TV setup menus (TV is in Pass-through Mode) or the Function Menu (TV is not in Pass-through Mode).
3. (TV in Pass-through Mode only) From the Quick Settings Menu displayed at the left of the screen, select the **All Settings**  menu icon and press **OK** to access the advanced TV setup menus.
4. Use the arrow navigation keys to select/highlight either the **General** menu icon from the TV setup menus or the **Safety** menu icon from the Function Menu. Then, press the number “7” key a total of seven times to access the TV Manager.

Note: Ez Download is always selected by default when you initially access the TV Manager. Also note that Diagnostics is for service use only.

5. If more than one USB memory device is currently connected to the TV, be sure to select the USB device that contains the applicable video file. If necessary, use the arrow keys on the Installer Remote to select/highlight the **USB DEVICE** button in the top right corner of the screen and press **OK**. Then, use the Up/Down arrow keys to select the appropriate USB device from the pop-up list of USB devices.

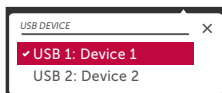

(Continued on next page)

Reference: Downloading a Hotel Video using a USB Memory Device (Cont.)

(Continued from previous page)

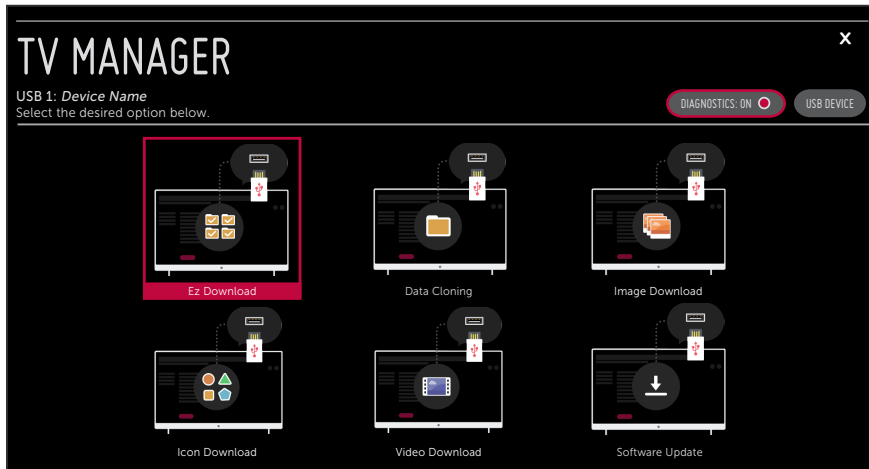

6. Use the arrow keys to select **Video Download**, and then press **OK**.
The Video Download screen will be displayed.

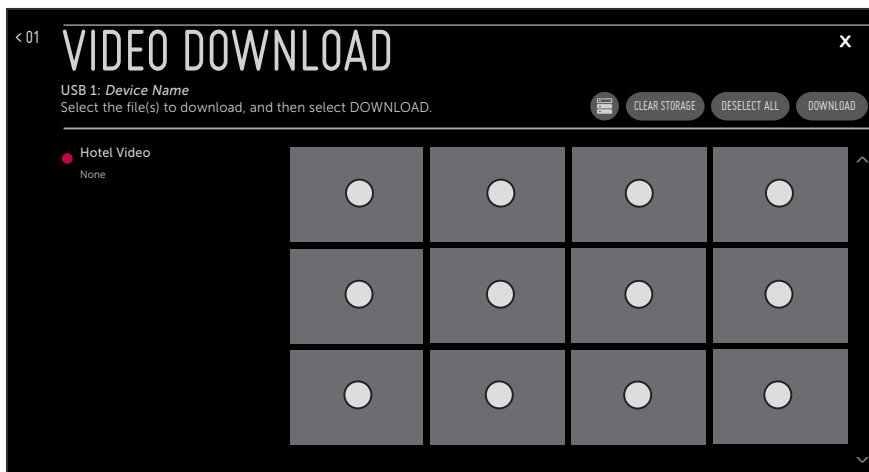

Note: You can select the  (STORAGE) button at the top of the screen to check the amount of storage available for and currently in use by media (image, icon, and video) files. Storage data will be displayed in a pop-up window. When you are finished, select **OK** to close the pop-up window. If you would like to clear the video file currently in storage, select the **CLEAR STORAGE** button. Then, in the confirmation pop-up window, select **YES** to clear the video file, or select **NO** to return to the Video Download screen without clearing the video file.

(Continued on next page)

Reference: Downloading a Hotel Video using a USB Memory Device (Cont.)

(Continued from previous page)

7. In the thumbnail area at the right of the screen, use the arrow keys to select/highlight the video file to download. Press **OK** to select a file (a checkmark  identifies a selected file). See also video guidelines at the beginning of this section.
8. When you are ready to download the video file, select **DOWNLOAD** on the screen, and then press **OK** on the Installer Remote.

Download progress will be displayed on the screen. Do NOT remove the USB device until the video download is complete. When the download process is complete, a "Video Download is completed" message will be displayed on the screen, and a "DONE" button will be displayed/activated at the top right of the screen.

9. Check the download status—at the left of the screen—for the video to make sure the download was successful, and then press **OK** on the Installer Remote to select **DONE**.

When you select "DONE," the Video Download screen will be redisplayed, and you can perform other TV Manager functions, as required.

Reference: Downloading a Pro:Idiom Media Key using a USB Memory Device

System providers may now define and apply their own Pro:Idiom Media Key (.pim) file to TVs at an installation site. This section describes how to download the Pro:Idiom Mobile Key file using the TV Manager Ez Download utility. Contact your LG service representative for further information on this feature.

Before You Begin

- Obtain the proper Pro:Idiom Media Key (.pim) file from the system provider. Avoid using special characters, such as ?, &, @, etc., in the filename.
- The Pro:Idiom Media Key file must be stored in a folder named “LG_DTV” in the root directory of the USB memory device.
- Ensure the USB device has been formatted with FAT format.

Download the Pro:Idiom Media Key File

⚠ Caution: If you restore the TV to a factory default condition, the default Pro:Idiom Media key will also be restored.

1. Turn ON the TV, and then insert the USB memory device into either of the USB ports on the TV.
2. Access the Ez Download utility (see “Ez Download Utility” on pages 37 to 41 for further information).
3. With the Ez Download screen on display, use the Up/Down arrow keys to select **Download Pro:Idiom M Key**, and then press **OK**.

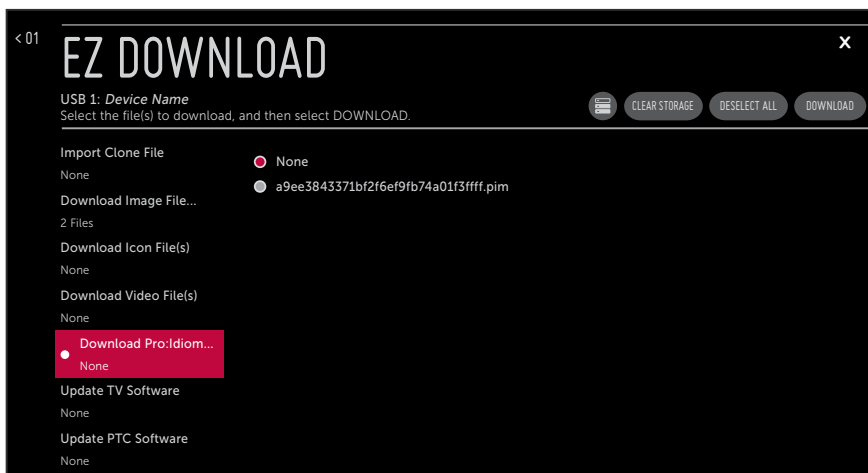

4. Use the arrow keys to select/highlight the Pro:Idiom Media Key file to download.
5. When you are ready to download the file, select **DOWNLOAD** on the screen, and then press **OK** on the Installer Remote.

Download progress will be displayed on the screen. Do NOT remove the USB device until the download is complete. When the Ez Download process is complete, an overview of the results will briefly be displayed and then, the TV will reboot.

6. Remove the USB memory device, and verify that the appropriate Pro:Idiom key is resident on the TV.

Reference: Power Consumption Settings

The following tables assume that Installer Menu item 099 BACK LIGHTING is set as shown below (default value is 255).

| Item 099 Back Lighting (Static) | 43UT782V | |
|------------------------------------|---------------------------|-----------------|
| | Power Consumption (Watts) | Percent Savings |
| 100 | 77.7 | 0% |
| 90 | 71.9 | 7% |
| 80 | 67.1 | 14% |
| 70 | 61.4 | 21% |
| 60 | 56.4 | 27% |
| 50 | 51.4 | 34% |
| 40 | 46.2 | 41% |
| 30 | 41.1 | 47% |
| 20 | 35.5 | 54% |
| 10 | 30.5 | 61% |
| 1 | 25.3 | 67% |

| Item 099 Back Lighting (Dynamic) | 43UT782V | |
|-------------------------------------|---------------------------|-----------------|
| | Power Consumption (Watts) | Percent Savings |
| 200 | 77.7 | 0% |
| 190 | 71.5 | 8% |
| 180 | 66.8 | 14% |
| 170 | 61.4 | 21% |
| 160 | 56.4 | 27% |
| 150 | 51.3 | 34% |
| 140 | 46.0 | 41% |
| 130 | 41.2 | 47% |
| 120 | 35.5 | 54% |
| 110 | 30.4 | 61% |
| 101 | 25.2 | 68% |

Note: Values are results of controlled experiments under laboratory conditions.

Reference: TV Aux Input Configuration

| DIRECT ACCESS Tuning * | | TV | | ENABLE | | | | | MPI DATA | | | | Installer Menu Item 046 START AUX SRCE (Start Aux Source) Value |
|--|--|--------------|---------------|----------------|-----------------|-------|--|-------------------|--|-------|---|---|---|
| | | | | Installer Menu | | | MPI DATA STATUS TYPE 0x41 SOURCES ENABLED (R/W) | | DATA STATUS TYPE 0xD2 CURRENT AV SOURCE (R) | | DATA STATUS TYPE 0x0D AUX SOURCE (R) | | |
| Installer Menu Item 029 REMAP AUX INPS = 0 | Installer Menu Item 029 REMAP AUX INPS = 1 | Aux Input | Input Mode | Item | Function | Value | Enable Bit | Label | Value | Value | Description | | |
| 131-0 | 91-0 | AV (Rear) | CV | 39 | REAR AUX EN | 1 | 1 | Rear Video (Aux) | 1 | 0 | VIDEO | 1 | |
| 132-0 | 92-0 | HDMI 2 | DTV | 91 | HDMI2 ENABLE | 1 | 2 | S-Video Rear | 2 | 0 | VIDEO | 5 | |
| | | | PC | | | 2 | | | | 2 | COMPUTER | | |
| 133-0 | 93-0 | HDMI 1 | DTV | 35 | HDMI1 ENABLE | 1 | 3 | Front Computer | 3 | 0 | VIDEO | 3 | |
| | | | PC | | | 2 | | | | 2 | COMPUTER | | |

* Use Installer Remote to enter channel number indicated based on REMAP AUX INPS Installer Menu setting.

Note: To add Aux inputs to an FTG Channel Map, use analog channel numbers in the 130 range, per table above, as the physical RF channel.

Reference: Auto Input(s) Sensing Feature

This section provides detailed settings information for Installer Menu item 042 AUTO INPUTS. To disable auto-sensing for all available Aux inputs, set item 042 to 0. To enable auto-sensing for all available Aux inputs, set item 042 to 255. For specifications on all other available settings (i.e., settings for individual inputs), refer to the Aux Inputs Values table on the following page.

Note: When both item 042 AUTO INPUTS *and* item 041 SIMPLINK EN are enabled in the Installer Menu, HDMI inputs will be detected by SIMPLINK, but the Auto Input(s) Sensing Feature will not function.

In the Installer Menu, an informational text code is displayed at the right of each Auto Inputs value, for example:

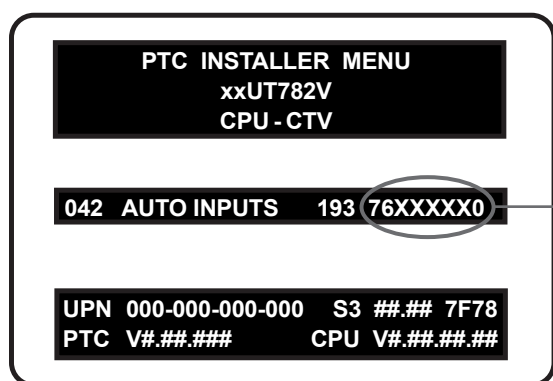

AUTO INPUTS Text Code

This example illustrates Installer Menu item 042 value 193, which enables auto-sensing for all available Aux inputs. The input #s in the text code (7, 6, 0 in this example) identify the enabled Aux inputs. See the Input # Assignments table below for a listing of the UT782V Aux inputs and their corresponding text code input #s. The Auto Inputs Values table on the following page shows the text codes for all item 042 values.

Each Auto Inputs text code consists of eight characters that identify the Aux input(s) for which auto-sensing is enabled. The following table identifies the Installer Menu text code input # for each Aux input that is available on the UT782V TV models. The table also identifies the Installer Menu item associated with each Aux input. Remember that in order for auto-sensing to be enabled for an input, that input must also be enabled in the Installer Menu.

Input # Assignments

| Installer Menu Text Code Input # | Aux Input | Installer Menu | |
|----------------------------------|-----------|----------------|--------------|
| | | Item | Function |
| 0 | AV | 039 | REAR AUX EN |
| 6 | HDMI 1 | 035 | HDMI1 ENABLE |
| 7 | HDMI 2 | 091 | HDMI2 ENABLE |

Reference: Auto Input(s) Sensing Feature (Cont.)

The following table shows all available Aux inputs as if each is enabled in the Installer Menu. The Installer Menu text codes for item 042 will be altered accordingly if any of the available Aux inputs are disabled in the Installer Menu.

Auto Inputs Values

| Item 042 Value | Aux Inputs | | | Installer Menu Text Code |
|----------------|------------|----------|----------|--------------------------|
| | AV | HDMI 1 | HDMI 2 | |
| 000 | Disabled | Disabled | Disabled | DDXXXXXD |
| 001 | Enabled | Disabled | Disabled | DDXXXXX0 |
| 064 | Disabled | Enabled | Disabled | D6XXXXXD |
| 065 | Enabled | Enabled | Disabled | D6XXXXX0 |
| 128 | Disabled | Disabled | Enabled | 7DXXXXXD |
| 129 | Enabled | Disabled | Enabled | 7DXXXXX0 |
| 192 | Disabled | Enabled | Enabled | 76XXXXXD |
| 193 | Enabled | Enabled | Enabled | 76XXXXX0 |
| 255 | Enabled | Enabled | Enabled | 76XXXXX0 |

X = Aux input is Disabled or Not Available (i.e., on these TV models)

D = Auto-sensing for input is Disabled

Input # = Auto-sensing for input is Enabled

Reference: Restoring Factory Defaults on the TV(s)

This section describes how to restore all factory defaults or just the Installer Menu factory defaults either on a single TV that is currently in Pass-through Mode, FTG Mode, Application Tuning Mode, etc. or on multiple TVs that are currently in FTG Mode.

Restore All Factory Defaults

This section describes how to restore a single TV, regardless of its mode, to a factory default condition. The following procedure requires that you contact LG technical support to obtain a predefined value/password for Installer Menu item 117 FACT DEFAULT that enables access to initiate a factory “IN-STOP” process, which restores all factory defaults. This procedure will also reactivate the First Use Wizard.

1. Use the Installer Remote to access the TV’s Installer Menu.
2. Navigate to Installer Menu item 117 FACT DEFAULT, and key in the value provided by technical support. Then, press **OK**.
3. At the prompt for confirmation, key in the password provided by technical support. This will initiate the IN-STOP that restores the factory defaults on the TV.

Installer Menu Item 117 FACT DEFAULT

If the TV is currently in Pass-through Mode, you can set Installer Menu item 117 FACT DEFAULT to 1 to restore the Installer Menu factory defaults and clear the PTC Channel Map, including any assigned channel icons and custom text labels. Note, however, that if a complete restoration of the TV’s factory defaults is required, see “Restore All Factory Defaults” above.

Additional FTG Mode Options

There are two additional options for restoring Pass-through Mode/Installer Menu factory defaults on TVs that are in FTG Mode. The first enables you to restore a single TV to Pass-through Mode, while the second enables you to restore multiple TVs to Pass-through Mode at one time. However, both options require that you create a “Restore_Pass-through_Mode.tlx” file, i.e., an FTG Configuration file with no data. Refer to the **Cloud Configuration Tool User Guide** for further information.

- Using a USB memory device, import a “Restore_Pass-through_Mode.tlx” file to the TV. Refer to “Importing a Clone File” on pages 59 to 63 for further information on the import procedure.
- If your system uses a Pro:Centric server for remote management of UT782V TVs that are in FTG Mode, use the Pro:Centric Admin Client to load a “Restore_Pass-through_Mode.tlx” file on the Pro:Centric server. Refer to the **Pro:Centric Server Admin Client User Guide** for further information.

Reference: Using the TV's Zoning Features

This section describes the TV Zoning and Wi-Fi Zoning features available with the UT782V model TVs. These features are primarily intended for use when the TV is configured for FTG Mode operation; however, Wi-Fi Zoning, along with selected elements of TV Zoning (Installer Menu and Setup Menu profile Zone assignments), may also be used with TV cloning processes using a Clone (.tlx) file. Refer to the appropriate section(s) below for further information on the Zoning features and how to set the TV Zone # and/or Wi-Fi Zone # in a TV that is currently in Pass-through Mode.

TV Zoning Feature

The TV Zoning feature enables you to create localized configurations for TVs in selected “Zones” within the installation site, for example, a hotel lobby, fitness center, restaurant, etc.

Using the TV Zoning Feature with FTG Mode Configuration

The Cloud Configuration Tool may be used to create an FTG Configuration (.tlx) file that contains multiple Installer Menu and Setup Menu profiles, each with its own Zone assignment. Up to nine unique Zones can be designated for UT782V FTG Installer Menu and/or Setup Menu profiles. Zone restrictions can also be placed on individual channels in the FTG Channel Map. Thus, for example, you may create an FTG Installer Menu and/or Setup Menu profile to uniquely configure a TV in the hotel lobby and also restrict the channels that are available to be tuned on that TV.

The TV Zone # must be set appropriately on each TV in order for the TVs to be configured correctly. See “Set the TV Zone # and/or Wi-Fi Zone # in the TV” on page 100, and set the TV Zone # in all the TVs in a select area, so that the TVs are configured with corresponding FTG Installer Menu and/or Setup Menu settings and/or can omit channels that have been restricted in the FTG Channel Map. TV Zone 0 is the default TV Zone #.

The following subsections briefly describe how to assign Zones in the Cloud Configuration Tool. Refer to the **Cloud Configuration Tool User Guide** for further information.

FTG Installer Menu Profile Zone Assignments

The Cloud Configuration Tool / Installer Menu web page enables you to create multiple Installer Menu profiles for the same chassis model, each with a different Zone assignment (default = Zone 0), to be included in an FTG Configuration (.tlx) file. For example, you may wish to create one Installer Menu profile for the UT782V TV in the hotel lobby and another Installer Menu profile for the UT782V TV in the fitness center, both of which are different from the Installer Menu profile used for UT782V TVs in standard guest rooms. The TV Zoning feature enables you to save multiple UT782V FTG Installer Menu profiles, each with its own Zone assignment, in one FTG Configuration file. If each TV in each location (Zone) has had its TV Zone # set appropriately, as described in the procedure on page 100 or via the Solution Settings / EZ-Manager Wizard, the TV(s) will only be configured by the Installer Menu profile that matches its(their) Zone setting.

In the Cloud Configuration Tool / File Manager web page, you can also change the Zone assignment for each Setup Menu profile already present in the FTG Configuration List. See the File Manager and Installer Menu web page overviews on pages 67 and 69 for further information. Note that Setup Menu profiles cannot be created in the Cloud Configuration Tool; they must be saved (exported) from a TV.

Reference: Using the TV's Zoning Features (Cont.)

FTG Channel Map Zone Restrictions

In the Cloud Configuration Tool / Channel Map web page, you can place Zone restrictions on individual channels that may be prohibited or deemed unsuitable for certain locations. One or more Zone restrictions (1–8) may be placed on each channel that is to be restricted. For example, if you wish to restrict a channel from Zones 2 and 4, select both “Zone 2” and “Zone 4” in the Restricted from Zones field when defining or editing that channel.

Note: While a channel can be restricted from up to eight Zones, a TV can only ever be in (set for) one Zone. See also the Channel Map web page overview on page 68.

At the same time, keep in mind that the TV Zone designations are not mutually exclusive. That is, you may opt to place Zone restrictions on selected channels in the FTG Channel Map, but at the same time, you can choose to configure all TVs at the site with the same Installer Menu and/or Setup Menu settings. For example, an FTG Configuration (.tlx) file being used to configure the TVs at a site may contain multiple Installer Menu and Setup Menu profiles with different Zone assignments, as well as an FTG Channel Map with Zone restrictions on several channels. Each TV that still has the default TV Zone 0 setting will *only* be configured by the Installer Menu and/or Setup Menu profile(s) with a Zone 0 designation. If, on the other hand, the TV Zone # is set to 1, the TV will first look in the file for the UT782V Installer Menu and/or Setup Menu profile(s) with a Zone 1 designation. If none of the UT782V Installer Menu and/or Setup Menu profiles has a Zone 1 designation, the TV will then look for the UT782V profile(s) with a Zone 0 designation. For the FTG Channel Map configuration, when the TV Zone # is set to 0, the TV will ignore any Zone restrictions (1–8) that may be placed on channels in the FTG Channel Map. However, when the TV Zone # is set to 1, the TV will omit any channels that have been restricted from Zone 1 in the FTG Channel Map.

Using the TV Zoning Feature with Cloning Configuration

A location-specific configuration / Clone (.tlx) file may be saved (exported) from a Master TV and then be used to configure Target TVs. For example, if the TV Zone # in the Master TV is set to 3 before the Clone file export is initiated, the Master TV's Installer Menu and Setup Menu profiles will be saved with the TV Zone 3 assignment. In order to configure the Target TVs with the Zone 3 Installer Menu and Setup Menu profiles exported from the Master TV, you must set the TV Zone # accordingly in the Target TVs before importing the Clone file. See “Set the TV Zone # and/or Wi-Fi Zone # in the TV” on the following page. Also, see “Cloning Procedures” on pages 57 to 63 for additional information on the cloning processes. TV Zone 0 is the default TV Zone #.

Wi-Fi Zoning Feature

The Wi-Fi Zoning feature enables you to use a Clone/Configuration (.tlx) file to configure an individual TV or group of TVs with a particular Wi-Fi access point's login data to create “Wi-Fi Zones” within the installation environment.

Using the Wi-Fi Zoning Feature with FTG Mode Configuration

The Cloud Configuration Tool may be used to create an FTG Configuration (.tlx) file with an FTG Installer Menu profile that contains login data for multiple Wi-Fi access points, each assigned a Wi-Fi Zone #. Up to 100 Wi-Fi Zones can be designated within each FTG Installer Menu profile, thus allowing for distribution of the Wi-Fi network load. For example, if a site has 50 UT782V TVs within close proximity, you may wish to create 10 Wi-Fi Zones, each with its own access point that has unique login data, so that no more than five of the TVs are connected to one access point at any given time.

Reference: Using the TV's Zoning Features (Cont.)

In order for a TV to be configured by the proper Installer Menu profile with the desired Wi-Fi access point login data for wireless networking (i.e., SSID, security type, and security key), you must set both the TV Zone # and the Wi-Fi Zone # in the TV (see “Set the TV Zone # and/or Wi-Fi Zone # in the TV” below for further information). If the Wi-Fi Zone # in the TV is set to 0 (default), the TV will not obtain access point login data from the Installer Menu profile with which it is configured unless the profile contains the global Wi-Fi Zone 100. Any TV that does not find its matching Wi-Fi Zone # in the FTG Configuration file, but does find the global Wi-Fi Zone 100, will be configured with the global access point login data.

Refer to the **Cloud Configuration Tool User Guide** for further information on defining Wi-Fi Zones in the Cloud Configuration Tool.

Using the Wi-Fi Zoning Feature with Cloning Configuration

A location-specific Wi-Fi configuration / Clone (.tlx) file may be saved (exported) from a Master TV and then be used to configure Target TVs. First, the wireless network (i.e., the access point login data) must be configured in the Master TV's IP Environment Menu (see “Configuring a Wi-Fi Network Connection” on pages 72 to 73). Then, a Wi-Fi Zone # must be set in the Master TV (see “Set the TV Zone # and/or Wi-Fi Zone # in the TV” below). If desired, a TV Zone # may also be set in the Master TV.

For example, if the Wi-Fi Zone # is set to 4 and the TV Zone # is set to 5 before the Clone file export is initiated, the Master TV's Installer Menu profile will be saved with the Zone 5 assignment, and within that Installer Menu profile, the access point login data for wireless networking (i.e., SSID, security type, and security key) will be saved with a Wi-Fi Zone 4 assignment. In order to configure the Target TVs with the proper Installer Menu profile and access point login data, you must set both the TV Zone # and the Wi-Fi Zone # in the Target TVs accordingly before importing the Clone file. See “Set the TV Zone # and/or Wi-Fi Zone # in the TV” below. Also, see “Cloning Procedures” on pages 57 to 63 for additional information on the cloning processes. If the Wi-Fi Zone # in the TV is set to 0 (default), the TV will not obtain access point login data from the Installer Menu profile with which it is configured unless the profile contains the global Wi-Fi Zone 100. Any TV that does not find its matching Wi-Fi Zone # in the Clone file, but does find the global Wi-Fi Zone 100, will be configured with the global access point login data.

Set the TV Zone # and/or Wi-Fi Zone # in the TV

You can set the TV Zone # and/or the Wi-Fi Zone # in the Solution Settings / EZ-Manager Wizard (see “Solution Settings / EZ-Manager Wizard” on pages 25 to 36) or, if the TV is in Pass-through Mode, via the TV's setup menus as described below. Note that the following procedure can only be performed while the TV is in Pass-through Mode. You will also be able to specify a Label (North, South, East, West) and Room Number for this TV, if desired.

1. Turn ON the TV.
2. Press **MENU SETTINGS** on the Installer Remote, and use the arrow navigation keys to select/highlight the **General** menu option. Then, press **OK**.
3. In the General Menu, use the Up/Down arrow keys to select **Room Info**, and then press **OK**.
4. In the Room Info screen, complete the appropriate fields as described below. Use the Up/Down arrow keys on the Installer Remote to navigate between each of the fields.

(Continued on next page)

Reference: Using the TV's Zoning Features (Cont.)

(Continued from previous page)

- **Wi-Fi Zone:** Enables you to set a Wi-Fi Zone # so that the TV can be configured with a particular access point's login data for wireless networking. Login data (i.e., SSID, security type, and security key) may be provided in a Clone/Configuration (.tlx) file.

To assign a Wi-Fi Zone, select/highlight the **Wi-Fi Zone** field and press **OK**. Then, use the Left/Right arrow keys to specify the desired Wi-Fi Zone # (1–99). Press **OK** when you are finished.

- **TV Zone:** Enables you to set a TV Zone # so that the TV can be configured with Installer Menu and/or Setup Menu settings intended only for the assigned Zone. The Installer Menu and/or Setup Menu settings may be provided in a Clone/Configuration (.tlx) file. If the TV is being configured for FTG Mode, the TV Zone # setting also allows the TV to omit channels that have been restricted in the FTG Channel Map (see “FTG Channel Map Zone Restrictions” on page 99).

To change the TV Zone, select/highlight the **TV Zone** field and press **OK**. Then, use the Left/Right arrow keys to specify the desired TV Zone # (0–8). Press **OK** when you are finished.

- **Label:** Allows you to select a North, South, East, or West text label for this TV. Select/highlight the **Label** field and press **OK**. Then, use the Up/Down arrow keys to select the applicable label. Press **OK** when you are finished.
- **Room Number:** Allows you to specify the number of the room—up to 16 characters—in which the TV is located. To enter a room number, use the Up/Down arrow keys to select/highlight the **Room Number** field and press **OK**. You can then use the number keys on the Installer Remote to direct enter a room number, or you can use the arrow keys to select the appropriate alpha-numeric character(s) from the pop-up virtual keyboard at the bottom of the screen. When you are done, select **Enter** from the virtual keyboard, and then press **OK** on the Installer Remote.

Note: The TV name (default: TV serial number + model name) will be changed to the room number specified here. See “Media Share Setup” on pages 81 to 83 for further information on the TV name.

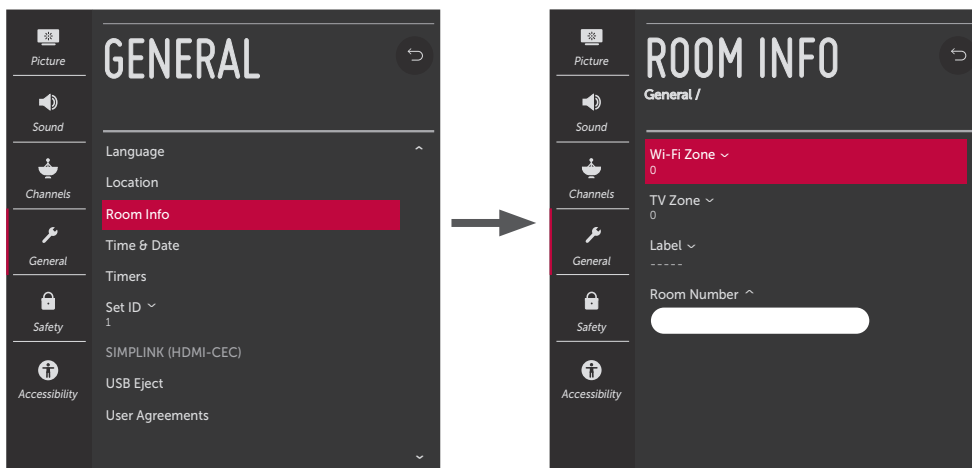

5. When you have completed the fields as necessary, press **↵** to return to and/or exit the TV menus, or press **MENU SETTINGS** to return to program viewing.

Reference: Using Media Share Features

When the appropriate Media Share options are enabled in the IP Environment / Media Share Menu, end users have the ability to use one or more of the Media Share features. See also “Media Share Setup” on pages 81 to 83.

This section provides an overview of the Smart Share, Screen Share, DIAL, and SoftAP functionality.



Note: Typically, only one Media Share feature may be used at a time. If one feature is currently in use, you may have to exit or turn it off in order to use/turn on another. In some cases, you will be prompted to confirm your action. Follow the display prompts as necessary.

Smart Share (DLNA Certified Devices)

The following steps describe how to access and use the Smart Share feature with DLNA Certified devices on the same LAN as the TV.

1. Turn ON the TV.
2. To access media files/folders on the TV, press **SMART** on the Installer Remote, and use the Left/Right arrow keys to select **Music** or **Photo & Video** from the TV's Smart Launcher.

Note: If the TV is not in Pass-through Mode, it is also possible to access the Music and Photo & Video options from the General Menu.

3. In the next screen (Music or Photo & Video, depending on your selection in the previous step), select the desired Smart Share device, and then select the desired file(s) to view.

Screen Share (Miracast / WiDi)

The following steps describe how to access and use the Screen Share feature to select a Miracast or WiDi capable device, whose screen can be displayed on the TV.

Note: This procedure describes how to access Screen Share from the TV's Smart Launcher. If the TV is not in Pass-through Mode, it is also possible to access Screen Share from the TV's General Menu.

1. Turn ON the TV, and then press **SMART** on the Installer Remote to display the TV's Smart Launcher.
2. Use the Left/Right arrow keys on the Installer Remote to select **Screen Share**, and then press **OK**.

Note: If Screen Share is not currently available in the Smart Launcher, you may need to exit/turn off another Media Share feature in order to use Screen Share. For example, select **Wi-Fi Service** (SoftAP) in the TV's Smart Launcher, and make sure that SoftAP is turned off. See also note above regarding simultaneous use of Media Share features.

3. Follow the on-screen instructions to initiate the Miracast / WiDi connection from your Miracast / WiDi device. Note that you may be prompted to enter a PIN number that appears on the TV screen into your Miracast / WiDi connection window to complete the connection.

Once the connection is established, the TV display may be used as a second screen for the Miracast / WiDi device.

Reference: Using Media Share Features (Cont.)

DIAL

The following steps describe how to access and use DIAL. Remember that the device used **MUST** be connected to the same network as the TV.

Note: DIAL may only be used with device applications for which a TV-compatible application (for example, YouTube) has been created/selected for inclusion in the Pre-loaded Apps Menu (see “Pre-loaded Applications” on page 80).

1. Turn ON the TV.
2. On your device, launch the desired application (see also note above, regarding the Pre-loaded Apps requirement), and use the appropriate options, typically available via Settings, to initiate a connection/pairing with the TV. You may also need to access the Settings options from the application on the TV to complete the pairing operation. Follow the on-screen instructions.

Once the connection/pairing is successful, you will be able to view media from the application on the TV.

SoftAP

The following steps describe how to access and use the SoftAP (Wi-Fi Service) feature.

Note: This procedure describes how to access SoftAP using the Wi-Fi Service option available from the TV's Smart Launcher. If the TV is not in Pass-through Mode, it is also possible to access SoftAP from the TV's General Menu.

1. Turn ON the TV, and then press **SMART** on the Installer Remote to display the TV's Smart Launcher.
2. Use the Left/Right arrow keys on the Installer Remote to select **Wi-Fi Service**, and then press **OK**.

Note: If a message is displayed indicating that Wi-Fi service is not currently available, make sure a wired LAN connection to the TV has been established.

3. When you initially access the Wi-Fi Service screen, the Off/On toggle button at the top right of the screen is selected/highlighted by default. If Wi-Fi Service is currently off, press **OK** on the Installer Remote to turn on Wi-Fi Service. When Wi-Fi Service is on, the Wi-Fi Service access information, including the SSID and security key, is displayed in the lower half of the screen.
4. Make sure Wi-Fi is turned on on your device, and then use the access information provided to initiate a connection to the TV's network.

Once a device is connected successfully to the TV's network, you can use it to access the Internet. Up to 10 devices may be connected at a time, though excessive use by some devices may diminish the performance of other devices and/or cause them to disconnect.

Note: A wired network connection **MUST** be established in order for guests to use SoftAP/Wi-Fi Service. Also, the SoftAP/Wi-Fi Service feature may only be used while the TV is turned ON.

Note: SoftAP supports both 2.4 GHz and 5 GHz Wi-Fi frequencies. If you are having difficulty with one Wi-Fi frequency, try the other.

Reference: UT782V Rear and Side Jack Panels

EXPANSION SLOT

Interface connector for a third-party expansion module. See also Reference section, "Expansion Interface Connector Specifications."

RS-232C IN (CONTROL & SERVICE)

When the TV is in Pass-through Mode, the RS-232C control function enables an external TLT control device (i.e., VOD/PPV STB, etc.) to control the TV. Service for factory use only.

MPI

When the TV is in Pass-through Mode, the MPI function enables an external MPI control device (i.e., VOD/PPV STB, etc.) to control the TV.

USB IN 1

Insert USB memory device for software updates, cloning purposes, FTG Mode configuration, picture/music entertainment, etc., as applicable.

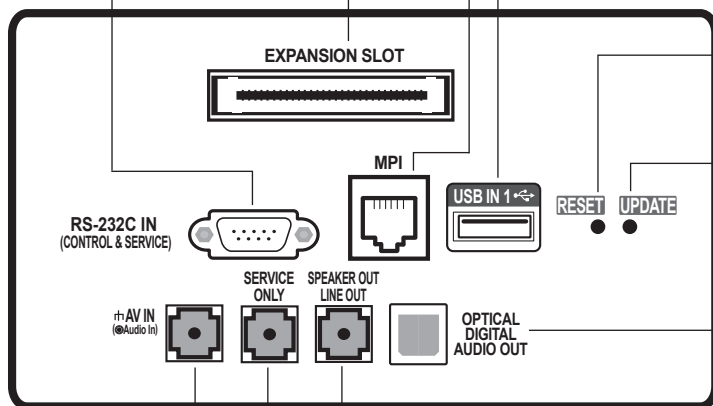

RESET

Initiates a hardware reset and turns the TV OFF.

UPDATE

Restricted to software updates.

OPTICAL DIGITAL AUDIO OUT

Use for amps and home theater systems. Note: When the TV is OFF, this port is not enabled.

AV IN

(3.5 mm jack) Connect video/audio output from external device (use A/V adapter cable provided with TV).

SERVICE ONLY

Typically used for downloading software updates, etc.

SPEAKER OUT / LINE OUT*

(3.5 mm jack) Connect external audio equipment. See also Reference section, "External Speaker/Audio Line Out Specifications."

* This jack is labeled AUDIO LINE OUT on UT782V9UA models.

Side Jack Panel

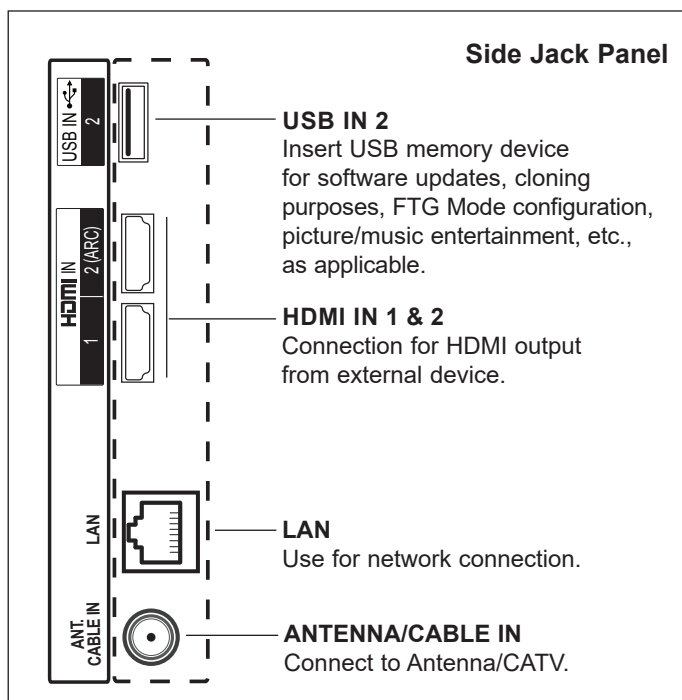

USB IN 2

Insert USB memory device for software updates, cloning purposes, FTG Mode configuration, picture/music entertainment, etc., as applicable.

HDMI IN 1 & 2

Connection for HDMI output from external device.

LAN

Use for network connection.

ANTENNA/CABLE IN

Connect to Antenna/CATV.

Reference: External Speaker/Audio Line Out Specifications

The SPEAKER OUT / LINE OUT 3.5 mm stereo jack on the UT782V0UA and UT782V2UA models provides Left/Right signal outputs (fixed speaker, variable speaker, or fixed line level) for external audio equipment, while the AUDIO LINE OUT 3.5 mm stereo jack on the UT782V9UA models provides stereo analog audio output for external audio equipment. Set Installer Menu item 097 AUDIO OUTPUT as required in accordance with both the applicable TV model, as well as the external audio equipment connected to the TV. Also, refer to the following diagram for pinout details.

⚠ Caution: Do NOT insert a mono (TS) plug, as this may damage the TV.

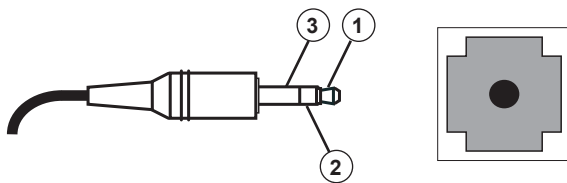

-
- | | |
|---|-----------------|
| 1 | LEFT (Tip) |
| 2 | RIGHT (Ring) |
| 3 | GROUND (Sleeve) |
-

Reference: Expansion Interface Connector Specifications

The EXPANSION SLOT on the UT782V rear panel provides an expansion interface connector for a third-party module, such as a DOCSIS/Wi-Fi AP module. For detailed information on electrical and mechanical specifications, contact your LG service representative. See also note below.

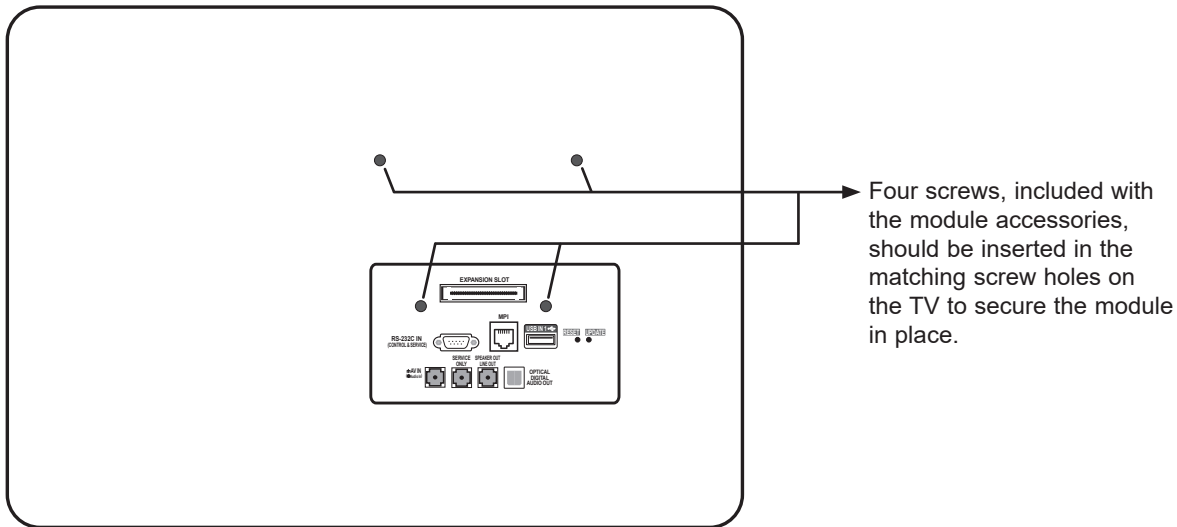

Note: For UT782V0UA models, the supply voltage at the expansion interface connector has a 1 Amp current limit. For UT782V2UA and UT782V9UA models, the supply voltage at the expansion interface connector has a 2 Amp current limit.

Reference: Installer Remote Control Typical Key Functions

The LG Installer Remote is supplied with and dedicated to operate the TV. The LG Installer Remote illustrated below shows typical remote control functions and is provided for reference only. This Installer Remote may vary from the Installer Remote supplied with the TV.

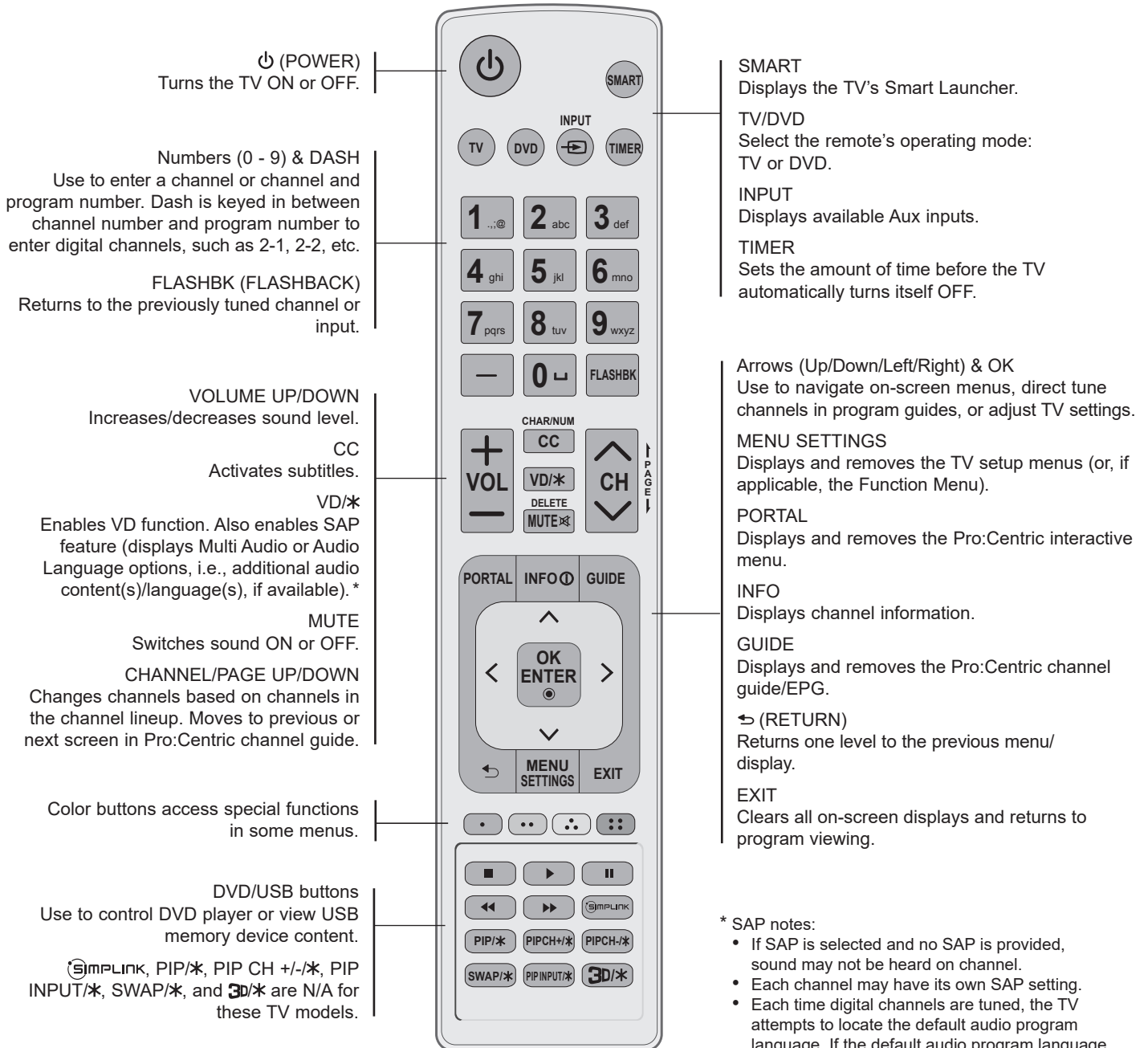

Reference: TLT Communication Parameters

Based on the setting of Installer Menu item 030 EXTCTL/ACKMASK, you may use the TV's RS-232C port for TLT communication purposes. See also "RS-232C Configuration" below.

RS-232C Configuration

**RS-232C IN (CONTROL)
DB9-Male Serial Port on TV**

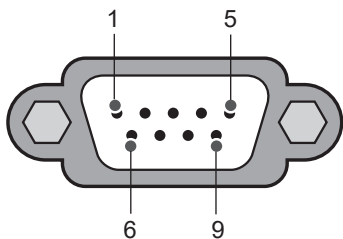

RS-232C IN (CONTROL) Port Pin Configuration

| Pin Number | Description | Pin Number | Description |
|------------|------------------------|------------|---------------|
| 1 | 3.5 V | 6 | No Connection |
| 2 | RXD | 7 | No Connection |
| 3 | TXD | 8 | No Connection |
| 4 | IR Data Pass-through * | 9 | No Connection |
| 5 | GND | | |

* Normally low signal with logic high pulses.

If your configuring device has a DB9-Male serial port, use a DB9-Female to DB9-Female null-modem (crossover) cable to connect the device to the TV.

Communication Parameters

- Baud rate: 9600 bps (UART)
- Parity: None
- Data length: 8 bits
- Stop bit: 1 bit

Command Reference List

Note: Commands may work differently depending on model and signal.

| | | Command 1 | Command 2 | Data (Hexadecimal) | | Command 1 | Command 2 | Data (Hexadecimal) | |
|-----|----------------|-----------|-----------|--------------------|-----|--------------------------|-----------|--------------------|----------------|
| 01. | Power | k | a | 00 / 01 | 11. | OSD Select | k | l | 00 / 01 |
| 02. | Aspect Ratio | k | c | (see page 110) | 12. | Remote Control Lock Mode | k | m | 00 / 01 |
| 03. | Screen Mute | k | d | 00, 01, 10 | 13. | Balance ** | k | t | 00–64 |
| 04. | Volume Mute | k | e | 00 / 01 | 14. | Color Temperature * | x | u | 00–64 |
| 05. | Volume Control | k | f | 00–64 | 15. | Equalizer | j | v | (see page 112) |
| 06. | Contrast * | k | g | 00–64 | 16. | Tune Command | m | a | (see page 112) |
| 07. | Brightness * | k | h | 00–64 | 17. | Channel Add/Delete | m | b | 00 / 01 |
| 08. | Color * | k | i | 00–64 | 18. | Key | m | c | (see page 113) |
| 09. | Tint * | k | j | 00–64 | 19. | Control Backlight | m | g | 00–64 |
| 10. | Sharpness * | k | k | 00–32 | 20. | Input Select (Main) | x | b | (see page 113) |

* These features are also adjustable in the Picture Menu.

** This feature is also adjustable in the Sound Menu.

Reference: TLT Communication Parameters (Cont.)

Transmitting / Receiving Protocol

This communication protocol transmits and receives 1-byte ASCII data representation for each Command, Set ID, and Data character. Therefore, a standard ASCII terminal program can be used to send and receive the protocol.

Command Structure

[Command1][Command2][][Set ID][][Data][CR]

The following table describes the parameters.

| | |
|-------------|---|
| [Command 1] | First part of command to control the TV: j, k, m, or x. Corresponding transmission data of 0x6A, 0x6B, 0x6D, or 0x78, respectively. |
| [Command 2] | Second part of command to control the TV. |
| [Set ID] | Choose the [Set ID] value to match the Set ID number in the General Menu. The Set ID valid range is decimal 1 to 99. If the [Set ID] value is sent as [00], every connected display will act on the command. Note: The [Set ID] value should be entered in an ASCII terminal program as hexadecimal 00 to 63 values; however, note that each character of the hexadecimal value is transmitted as the ASCII value of that character. For example: [00] since ASCII 0=0x30, would be sent as "3030" [0A] since ASCII A=0x41, would be sent as "3041" [63] since ASCII 6=0x36 & ASCII 3=0x33, would be sent as "3633" |
| [Data] | Enter the command's required data (hexadecimal—see [Set ID] note above for correct translation). Enter Data [FF] to read status of the function. |
| [CR] | Carriage Return (ASCII value 0x0D) |
| [] | Space (ASCII value 0x20) |

OK Acknowledgment

[Command2][][Set ID][][OK][Data][x]

The display responds with OK acknowledgment in the format shown above after receiving valid Command and Data values. The lowercase [Data] value in the response is either the current status (if Data [FF] was sent) or the [Data] value, regardless of case, that was sent in the acknowledged control command.

Error Acknowledgment

[Command2][][Set ID][][NG][Data][x]

The display responds with NG (error) acknowledgment in the format shown above after receiving abnormal data from non-viable functions or communication errors. The lowercase [Data] value in the response is the [Data] value, regardless of case, that was sent in the acknowledged control command.

Reference: TLT Communication Parameters (Cont.)

Data Conversion (Hexadecimal : Decimal)

In cases where decimal values are shown in commands, refer to following conversion examples to enter the [Data] value in the terminal program as hexadecimal.

Note: The Channel Tune (ma) Command uses two-byte hexadecimal values ([Data]) to represent the channel number.

| | | |
|--------------------------|--------------------------|---------------------|
| 00: Step 0 | 32: Step 50 or Set ID 50 | FE: Step 254 |
| 01: Step 1 or Set ID 1 | 33: Step 51 or Set ID 51 | FF: Step 255 |
| ... | ... | ... |
| 0A: Step 10 or Set ID 10 | 63: Step 99 or Set ID 99 | 01 00: Channel 256 |
| ... | ... | ... |
| 0F: Step 15 or Set ID 15 | C7: Step 199 | 27 0E: Channel 9998 |
| 10: Step 16 or Set ID 16 | C8: Step 200 | 27 0F: Channel 9999 |
| ... | ... | ... |

TLT Command Detailed Descriptions

Note: Commands may work differently depending on model and signal.

01. Power (Command: k a)

- To control TV power (ON/OFF).

Command (Control) Structure

```
[k][a][ ][Set ID][ ][Data][CR]
```

[Data] Values:

00: Power Off
01: Power On

Acknowledgment

```
[a][ ][Set ID][ ][OK/NG][Data][x]
```

- To show TV power status (ON/OFF).

Command (Status) Structure*

```
[k][a][ ][Set ID][ ][FF][Cr]
```

Acknowledgment

```
[a][ ][Set ID][ ][OK][Data][x]
```

* Similarly, when Data [FF] is sent for other functions (based on this format), the Acknowledgment feedback returns status about each function.

02. Aspect Ratio (Command: k c)

To adjust the aspect ratio.

Command Structure

```
[k][c][ ][Set ID][ ][Data][CR]
```

[Data] Values:

01: Normal Screen (4:3)
02: Wide Screen(16:9)

04: Zoom

06: Set by Program/Original
09: Just Scan
10 to 1F: Cinema Zoom 1 to 16
0C: Cinemascope (21:9)

Acknowledgment

```
[c][ ][Set ID][ ][OK/NG][Data][x]
```

- Using the PC input, you can select either 16:9 or 4:3 screen aspect ratio.
- In DTV/HDMI/Component mode (high-definition), Just Scan is available.
- Full wide mode may work differently based on model and is supported for DTV fully and ATV / AV partially.

03. Screen Mute (Command: k d)

To control screen mute.

Command Structure

```
[k][d][ ][Set ID][ ][Data][CR]
```

[Data] Values:

00: Screen Mute Off (Picture On)
Video Mute Off
01: Screen Mute On (Picture Off)
10: Video Mute On*

Acknowledgment

```
[d][ ][Set ID][ ][OK/NG][Data][x]
```

* In case of Video Mute On only, the TV will show OSD. In case of Screen Mute On, the TV will not show OSD.

Reference: TLT Communication Parameters (Cont.)

04. Volume Mute (Command: k e)

To control volume mute.

Command Structure

```
[k][e][ ][Set ID][ ][Data][CR]
```

[Data] Values:

00: Volume Mute On (Volume Off)

01: Volume Mute Off (Volume On)

Acknowledgment

```
[e][ ][Set ID][ ][OK/NG][Data][x]
```

05. Volume Control (Command: k f)

To adjust volume.

Command Structure

```
[k][f][ ][Set ID][ ][Data][CR]
```

[Data] Values:

00 (minimum) to 64 (maximum)

Acknowledgment

```
[f][ ][Set ID][ ][OK/NG][Data][x]
```

06. Contrast (Command: k g)

To adjust screen contrast.

Command Structure

```
[k][g][ ][Set ID][ ][Data][CR]
```

[Data] Values:

00 (minimum) to 64 (maximum)

Acknowledgment

```
[g][ ][Set ID][ ][OK/NG][Data][x]
```

07. Brightness (Command: k h)

To adjust screen brightness.

Command Structure

```
[k][h][ ][Set ID][ ][Data][CR]
```

[Data] Values:

00 (minimum) to 64 (maximum)

Acknowledgment

```
[h][ ][Set ID][ ][OK/NG][Data][x]
```

08. Color (Command: k i)

To adjust the screen color.

Command Structure

```
[k][i][ ][Set ID][ ][Data][CR]
```

[Data] Values:

00 (minimum) to 64 (maximum)

Acknowledgment

```
[i][ ][Set ID][ ][OK/NG][Data][x]
```

09. Tint (Command: k j)

To adjust the screen tint.

Command Structure

```
[k][j][ ][Set ID][ ][Data][CR]
```

[Data] Values:

00 (Red) to 64 (Green)

Acknowledgment

```
[j][ ][Set ID][ ][OK/NG][Data][x]
```

10. Sharpness (Command: k k)

To adjust the screen sharpness.

Command Structure

```
[k][k][ ][Set ID][ ][Data][CR]
```

[Data] Values:

00 (minimum) to 32 (maximum)

Acknowledgment

```
[k][ ][Set ID][ ][OK/NG][Data][x]
```

11. OSD Select (Command: k l)

To select OSD (On Screen Display) status when controlling remotely.

Command Structure

```
[k][l][ ][Set ID][ ][Data][CR]
```

[Data] Values:

00: OSD Off

01: OSD On

Acknowledgment

```
[l][ ][Set ID][ ][OK/NG][Data][x]
```

12. Remote Control Lock Mode (Command: k m)

To lock both the display panel button functions and remote control IR features.

Command Structure

```
[k][m][ ][Set ID][ ][Data][CR]
```

[Data] Values:

00: Lock Off

01: Lock On

Reference: TLT Communication Parameters (Cont.)

[Data3][Data4]: Minor Channel number

- Data3: High byte channel data
- Data4: Low byte channel data
00 00–03 E7 (Decimal: 0–999)

[Data5]: Input Source (Digital)[†]

- 02: Antenna (DTV), Use Physical Channel number
- 06: Cable (Auto^{††}) (CADTV), Use Physical Channel number
- 22: Antenna (DTV), Do not use Physical Channel number (see also [Data0] ** above)
- 26: Cable (Auto^{††}) (CADTV), Do not use Physical Channel number (see also [Data0] ** above)
- 46: Cable (Auto^{††}) (CADTV), Use Physical Major Channel number only (One Part Channel)
- 66: Cable (Auto^{††}) (CADTV), Use Major Channel number only (One Part Channel), Do not use Physical Channel number (see also [Data0] ** above)

[†] Installer Menu items 003 BAND/AFC and 102 ATSC BAND select the tuning band(s) for the display. In order for the tune command to be executed, the Input Source value for Data5 must match each tuner's tuning band setting.

^{††} Cable bands Cable Std - x3, Cable HRC - x4, and Cable IRC - x5 can also be used in [Data5] lower nibble.

Two bytes are available for each Major and Minor Channel number. The high byte is 00 unless the channel number exceeds 255.

Tune Command Examples:

Example 1: Tune to analog (NTSC) channel 35

Set ID = All = 00
Data0 = Channel Data is 35 = 23
Data1 & Data2 = No Major = 00 00
Data3 & Data4 = No Minor = 00 00
Data5 = Analog Cable TV = 01
Total = ma 00 23 00 00 00 00 01

Example 2: Tune to digital (ATSC) channel 30-3

Set ID = All = 00
Data0 = Don't know Physical = 00
Data1 & Data2 = Major is 30 = 00 1E
Data3 & Data4 = Minor is 3 = 00 03
Data5 = Digital Antenna TV = 22
Total = ma 00 00 00 1E 00 03 22

Acknowledgment

```
[a][ ][Set ID][ ][OK][Data 0][Data1]
[Data2][Data3][Data4][Data5][x]
[a][ ][Set ID][ ][NG][Data0][x]
```

17. Channel Add/Delete (NTSC) (Command: m b)

To set the saved channel status.

Command Structure

```
[m][b][ ][Set ID][ ][Data][CR]
```

[Data] Values:

- 00: Delete
- 01: Add

Acknowledgment

```
[b][ ][Set ID][ ][OK/NG][Data][x]
```

18. Key (Command: m c)

To send IR remote key code.

Command Structure

```
[m][c][ ][Set ID][ ][Data][CR]
```

See Key Codes table on page 114 for [Data] values.

Acknowledgment

```
[c][ ][Set ID][ ][OK/NG][Data][x]
```

19. Control Backlight (Command: m g)

To control the backlight.

Command Structure

```
[m][g][ ][Set ID][ ][Data][CR]
```

[Data] Values:

- 00 (minimum) to 64 (maximum)

Acknowledgment

```
[g][ ][Set ID][ ][OK/NG][Data][x]
```

20. Input select (Command: x b)

To select input source for main picture.*

Command Structure

```
[x][b][ ][Set ID][ ][Data][CR]
```

[Data] Values:

- | | |
|-------------------|-----------------|
| 00: DTV | 41: Component 2 |
| 01: CADTV | 60: RGB |
| 02: Satellite DTV | 90: HDMI 1 |
| 10: ATV | 91: HDMI 2 |
| 11: CATV | 92: HDMI 3 |
| 20: AV or AV 1 | 93: HDMI 4 |
| 21: AV 2 | |
| 40: Component 1 | |

Acknowledgment







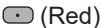

```
[b][ ][Set ID][ ][OK/NG][Data][x]
```

* This function depends on model and signal.

Reference: TLT Communication Parameters (Cont.)

Key Codes

The following table provides typical LG key codes. Some keys are not applicable to all models.

| Code (Hexa) | Function | Code (Hexa) | Function |
|-------------|---------------------|-------------|--|
| 00 | CH UP | C0 |  (Green) |
| 01 | CH DOWN | C1 |  (Red) |
| 02 | VOL UP | C2 |  (Yellow) |
| 03 | VOL DOWN | C3 |  (Blue) |
| 06 | > (Right Arrow) | 8E |  (Fast Forward) |
| 07 | < (Left Arrow) | 8F |  (Rewind) |
| 40 | ^ (Up Arrow) | B0 |  (Play) |
| 41 | v (Down Arrow) | B1 |  (Stop) |
| 08 | POWER (toggle) | BA |  (Pause) |
| C4 | POWER ON | AA | INFO |
| C5 | POWER OFF | AB | GUIDE |
| 09 | MUTE | 7C | SMART |
| 10–19 | Numbers (0–9) | 7E | SIMPLINK |
| 28 | BACK | DC | 3D |
| 39 | CC (Closed Caption) | 60 | PIP |
| 43 | MENU SETTINGS | 61 | PIP INPUT |
| 44 | OK/ENTER | 63 | PIP SWAP |
| 0A | SAP | 71 | PIP CH UP |
| 0B | INPUT | 72 | PIP CH DOWN |
| 0C | PORTAL | 79 | ASPECT RATIO |
| 0E | TIMER | 91 | VIDEO DESCRIPTION |
| 1A | FLASHBACK | CE | HDMI 1 |
| 4C | DASH | CC | HDMI 2 |
| 5B | EXIT | E9 | HDMI 3 |
| D6 | TV | DA | HDMI 4 |
| 5A | VIDEO 1 | BF | COMPONENT 1 |
| D0 | VIDEO 2 | D4 | COMPONENT 2 |
| D5 | RGB | | |

Some Quick and Easy Tips for Resolving Problems

Installation

| Symptom | Possible Cause(s) | Possible Solution(s) |
|-------------------------------------|---|--|
| Cannot direct enter channel number. | (TV in Pass-through Mode) Installer Menu item 028 CH. OVERRIDE is set to 0, i.e., disabled (recommended setting). | If Installer Menu item 028 CH. OVERRIDE is set to 0, only channels that are active in the TV's channel lineup can be selected. Set CH. OVERRIDE to 1 to allow access for direct keypad entry to all channels. |
| | (TV not in Pass-through Mode) The channel entered is not included in the applicable Channel Map. | Channel access is restricted to channels included in the applicable Channel Map, for example the FTG Channel Map if the TV is in FTG Mode or the Pro:Centric Direct Channel Map if the TV is in Application Tuning Mode with Pro:Centric Direct. If necessary, make changes to the Channel Map using the appropriate application/content editor. |

Picture Reception and Sound

| Symptom | Possible Cause(s) | Possible Solution(s) |
|-----------------------------------|------------------------------|---|
| No picture. | TV is turned OFF. | <ul style="list-style-type: none"> • Turn TV ON. • Power failure? |
| | Antenna/cable not connected. | Connect antenna/cable signal to TV. |
| | Connections incorrect. | Check connections on TV. |
| | MPI not connected. | If applicable, connect MPI cable to MPI device. |
| | Encrypted program. | Try another channel. |
| | Wrong tuning band. | Adjust Installer Menu settings. |
| Normal picture, poor or no sound. | Audio muted. | Press MUTE or use Volume Up key to increase sound level. |
| | Broadcast problem. | Try a different channel. |

Erratic Operation

| Symptom | Possible Cause(s) | Possible Solution(s) |
|-----------------------|--------------------------------|---|
| Installer Menu setup. | Wrong Installer Menu settings. | Adjust Installer Menu settings as required. |

Installer Remote

| Symptom | Possible Cause(s) | Possible Solution(s) |
|----------------------|---|---|
| Remote doesn't work. | Remote not in TV Mode. | Use MODE key to select "TV"; puts remote into TV Mode. |
| | Not aimed at IR receiver. | Point remote at IR receiver on TV. |
| | Remote too far from IR receiver or IR path is obstructed. | Move remote closer to IR receiver on TV, darken room, and/or remove obstructions. |
| | MPI not connected. | If applicable, connect MPI cable to MPI device. |
| | Weak batteries. | Replace batteries. |
| | Wrong battery polarity. | Check that "+" and "-" match in battery compartment. |
| | Too much light in room. | Dim room light. |
| | Wrong Installer Remote. | Requires compatible LG Installer Remote. Contact your LG representative. |

Troubleshooting (Cont.)

Commercial Mode Check

Use this flowchart to determine whether the TV is currently in Commercial Mode.

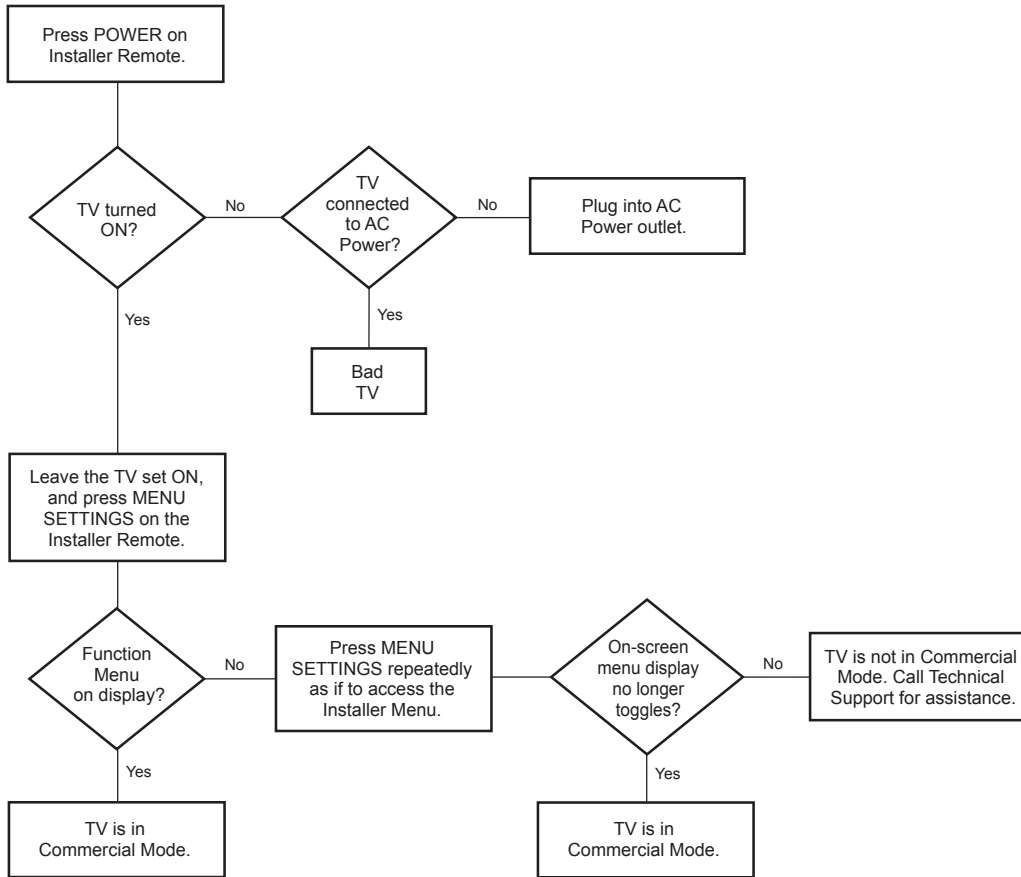

Application Tuning Mode

LG commercial TV mode that enables the TV's Channel Map to reside in a Pro:Centric application.

Basic Settings Wizard

Lodging model TV configuration wizard that provides basic settings options. Includes Channel Tuning.

Channel Lineup

Channels set in the TV memory, via Auto Tuning/manual editing.

Channel Map

Typically refers to a logical channel mapping of physical channels (for example, an FTG Channel Map). This allows digital channels, like analog channels, to be tuned without requiring the dash key. Also, channels (analog or digital) can be arranged in any order that seems logical for customer tuning/viewing.

Cloning

The process of capturing a Master TV Setup and transferring it to a Target TV using a USB memory device.

Commercial Mode

A mode of operation that provides a broad range of commercial TV features based on control (settings) provided by the PTC and/or an MPI control device.

CPU

The TV's Central Processing Unit. Responsible for the presentation of video and audio from content received via the TV's tuner or Aux inputs.

E-Z Installation

Enables boot logo image, TV configuration, and software file downloads to selected TV models from a Pro:Centric server. Managed and administered via the appropriate Pro:Centric Admin Client.

EZ-Manager Wizard

Lodging model TV configuration wizard that provides configuration options for Pro:Centric operation as well as an option for using a USB memory device to configure a TV.

FTG Mode

LG commercial TV mode that enables decryption of Pro:Idiom encrypted channels and logical channel mapping. TVs may be configured locally using LG's proprietary

Cloud Configuration Tool or remotely using an applicable head end device.

Function Menu

Available via Installer Remote "MENU" key. Indicates the TV is not in Pass-through Mode. Restricts menu options to a subset of the TV setup menus, allowing users to retain functional control, while disabling setup options.

Installer Menu

Defines commercial TV functionality based on the parameters set.

LG Free-To-Guest (FTG)

Refers to a particular commercial mode of operation within an LG TV. See also FTG Mode.

Logical Channel Number

A number assigned to either a physical or virtual channel number in a Logical Channel Map.

Major Channel Number

Typically, the RF channel number assigned to a digital video stream.

Master TV

A TV whose Channel Map and Installer Menu and TV setup menu settings have been configured as a Master TV Setup for cloning purposes.

Minor Channel Number

A sub-channel or program number assigned to the content embedded in the digital video stream.

MPI

Multiple Protocol Interface. An MPI port or, for some TV models, an MPI card slot provides external control options for solution providers.

Pass-through Mode

The TV's factory default mode of operation. TVs can be configured for stand-alone use or as Master TVs for cloning purposes, and/or TVs may be controlled externally in this mode.

Physical Channel Number

The major channel number assigned to represent a specific 6 MHz RF band as specified by either the broadcast or CATV channel plan. See CEA (formerly EIA) or NCTA specifications for further information.

Pro:Centric Application

LG content delivery and communication interface powered by a Pro:Centric server, that provides interactive entertainment, weather, amenities, etc. information for end users. Two application options are available: Pro:Centric Java application or Pro:Centric Direct HTML application.

Pro:Centric Admin Client

Web editor/content wizard provided for service provider and customer configuration of Pro:Centric application and management elements. The proper Admin Client must be used in accordance with licensed (Java or HTML) application.

Pro:Idiom

Zenith proprietary security software that unlocks access to premium content to help assure rapid, broad deployment of HDTV and other high-value digital content.

PTC

Protocol Translation Controller. The commercial controller (microprocessor) of the commercial TV.

Target TV

A TV to which a Master TV Setup will be transferred.

TV Setup Menus

Available via Installer Remote "MENU" key in Pass-through Mode only. Menus provide access to TV setup and functional features.

USB Memory Device

A USB flash drive or USB storage device, etc. that can be used for TV configuration purposes (typically cloning or FTG Mode via CPU configuration) or for updating TV software.

Virtual Channel Number

An alias (virtual) channel number provided in the data stream, by the broadcaster, of a digital broadcast channel to be displayed by consumer TVs in place of the physical channel number. The major number is the same as the original analog channel number and the minor number is the nth program available in that digital video stream.

Document Revision History / Open Source Software Notice

Document Revision History

| Date | Description |
|----------------|---|
| November 2019 | Revision A: New document |
| September 2020 | Revision B: Expansion interface connector update for amperage based on model |
| August 2021 | Revision C: 9UA, Installer Menu, and SoftAP updates |
| July 2024 | Revision D: External control, Installer Menu, TLT, and IP Environment updates |

Product documentation is available online at: www.lg.com/us/business.

Open Source Software Notice

To obtain the source code under GPL, LGPL, MPL and other open source licenses, that is contained in this product, please visit <http://opensource.lge.com>. In addition to the source code, all referenced license terms, warranty disclaimers and copyright notices are available for download. LG Electronics will also provide open source code to you on CD-ROM for a charge covering the cost of performing such distribution (such as the cost of media, shipping and handling) upon e-mail request to opensource@lge.com. This offer is valid for three (3) years from the date on which you purchased the product.



For Customer Support/Service, please call:

1-888-865-3026

www.lg.com/us/business

Pro:Idiom is a registered trademark of Zenith Electronics LLC. Pro:Centric, Smart Share, and the "LG" logo are registered trademarks of LG Electronics Inc. DLNA Certified is a registered trademark of Digital Living Network Alliance. Intel is a registered trademark of Intel Corporation in the U.S. and/or other countries. Miracast is a registered trademark of Wi-Fi Alliance. All other trademarks or registered trademarks are the property of their respective owners.